

STAFF DÉCOR

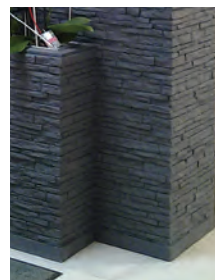

CATALOGUE
des collections

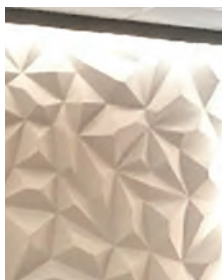
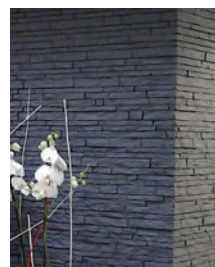
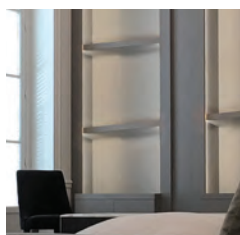

FABRICANT





UN ART
DE VIVRE À
LA FRANÇAISE

Le staff ne subit pas la mode,
il l'impose !

●
1979

1^{ère} corniche ornementée

●
1985

1^{ers} grands chantiers

●
1997

1^{ers} luminaires
suspendus

Créée par Daniel Morel en 1979, Staff Décor est avant tout l'histoire d'une entreprise familiale fière des valeurs humaines et éthiques qui ont fait son succès. Avec aujourd'hui plus de 150 salariés répartis entre l'usine et le siège social à Orgères au coeur de la campagne breillienne, ou dans l'une de ses 10 agences en France et en Allemagne, l'entreprise développe son savoir-faire autour de produits et objets de décoration en staff, réalisés à partir des plâtres de Paris. Leader dans son secteur et forte d'un beau rayonnement à l'international, Staff Décor conçoit et fabrique ses produits en Bretagne.



1999

1^{ères} réalisations
en Stratistaff

2013

Equipement d'une
machine 5 axes numérique

2014

Adhésion à la
Marque Bretagne

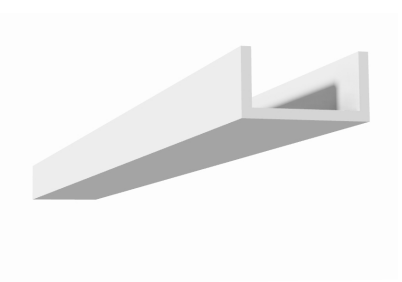

SOMMAIRE

NOUVEAUTÉS	6
LE PLAFOND	12
LES CORNICHES	16
LES MOULURES	38
LES ANGLES & DOUCINES DE MOULURES	44
LES ROSACES & CAISSONS DE PLAFOND	48
LA COLLECTION ORIENTALE	66
LES MURS	70
LES PANNEAUX 3D & PAREMENTS	74
L'HABILLAGE MURAL PAR LAMBRISSAGE	96
LES HABILLAGES DE PORTE	104
LES FRONTONS	106
LES COLONNES & LES PILASTRES	108
LES AGENCEMENTS & MOBILIERS	118
LES MODULOSTAFF & NICHES	122
LES TÊTES DE LIT	130
LES MEUBLES EN STAFF	132
LES PASSAGES & MEUBLES DE PASSAGE	138
LES CACHE-RADIATEURS	146
LES CHEMINÉES	150
LES LUMINAIRES	154
LES PRODUITS TECHNIQUES	160



D880B

> Largeur de l'ornement :
104 cm

© Anthony Gire

Nouveau cartouche pour corniche D880 !

En complément de notre écoinçon D880A et de la corniche D880, nous vous proposons de découvrir le cartouche finement ornementé D880B.

Idéal pour rompre le rythme de votre corniche et équilibrer votre espace !

Personnalisez vos appliques !

Faites y graver vos initiales,
des motifs ornementaux ou encore des pictogrammes de votre choix !
Adaptez-les à votre personnalité ou encore à votre marque !

Série d'appliques 110

> 46 x 46 cm





Ciel de lit en staff

> Dimensions partie haute :

140 x 190 cm

> Dimensions partie basse :

140 x 132 cm.

Découvrez une autre façon de styliser votre chambre à coucher !

Ciel de lit ou baldaquin en staff

Produit idéal pour surplomber une tête de lit préalablement installée ou encore s'y subtiliser ! N'hésitez pas à les détourner et à les décliner sans modération dans toutes les pièces de la maison !



AUTRES MOTIFS

Vous pouvez personnaliser vos baldaquins. D'autres modèles existent au sein de nos collections, pensez à demander avis à votre conseiller Staff Décor.



CL36

Prisme

122 x 122 cm

Conditionnement : à l'unité

Épaisseur : 3,2 cm

Surface : 1,49 m² / plaque

Poids unitaire : 18 kg

*Désormais dans
la gamme
standard !*

Réf CL37

Le Flore

2,60 x 1,23 m

Conditionnement : à l'unité



© CWF

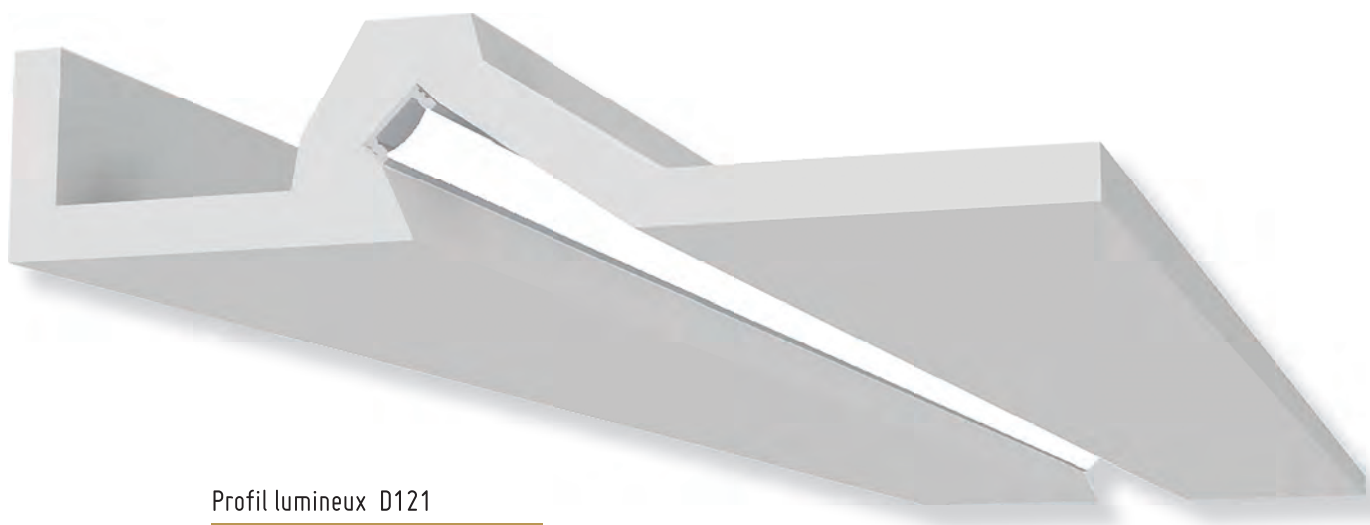

Profil lumineux D121
en 2 ml

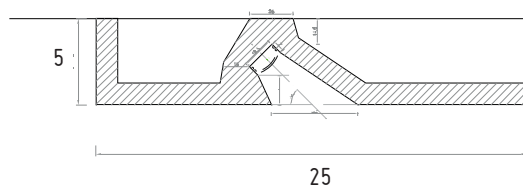

Bandeau lumineux BL180
en 2 ml
27,1 x 6,6 cm

Profil D118
en 2 ml
15 + 10 + 10 cm

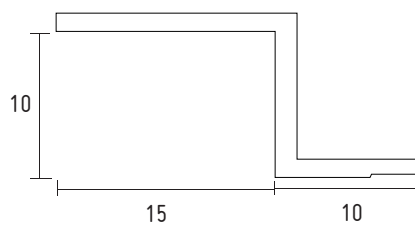
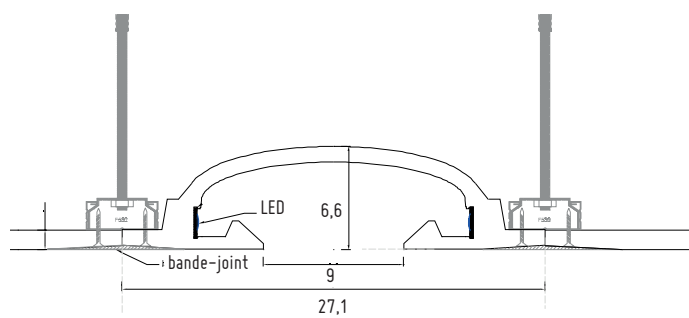

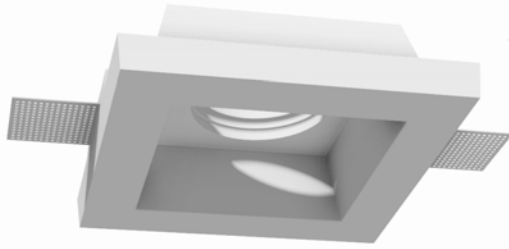

ENC31
12 x 12 x 3,8 cm
Pour spot Ø 5,1 cm
Finition : plâtre brut
Poids : 0,32 kg

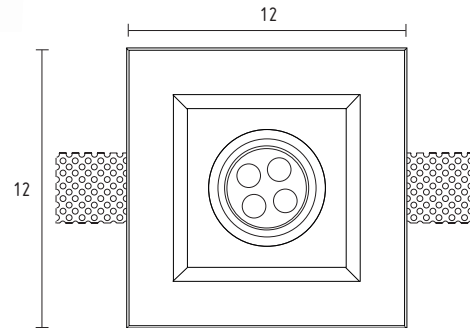

ENC32
12 x 12 x 3,8 cm
Pour spot Ø 5,1 cm
Finition : plâtre brut
Poids : 0,32 kg

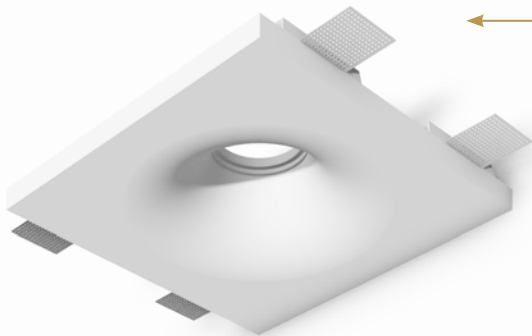
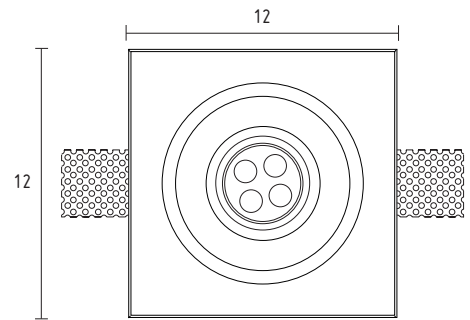
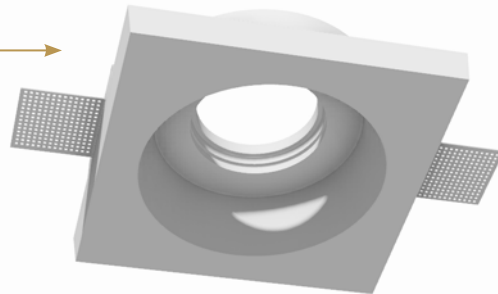

ENC35
18 x 18 x 5 cm
Pour spot Ø 5,1 cm
Finition : plâtre brut
Poids : 0,58 kg

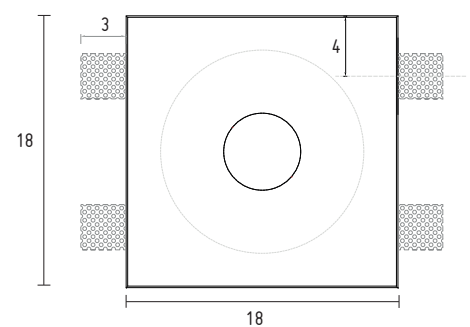



COUPOLE LUMINEUSE ENC41

76,4 x 76,4 x 17,5 cm

Attention : Il faudra impérativement prévoir un plénum de 19 cm pour l'ensemble de votre installation.

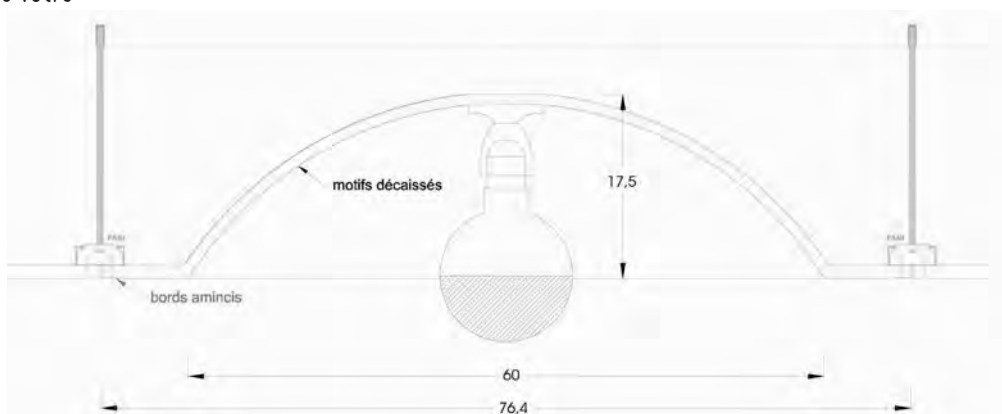

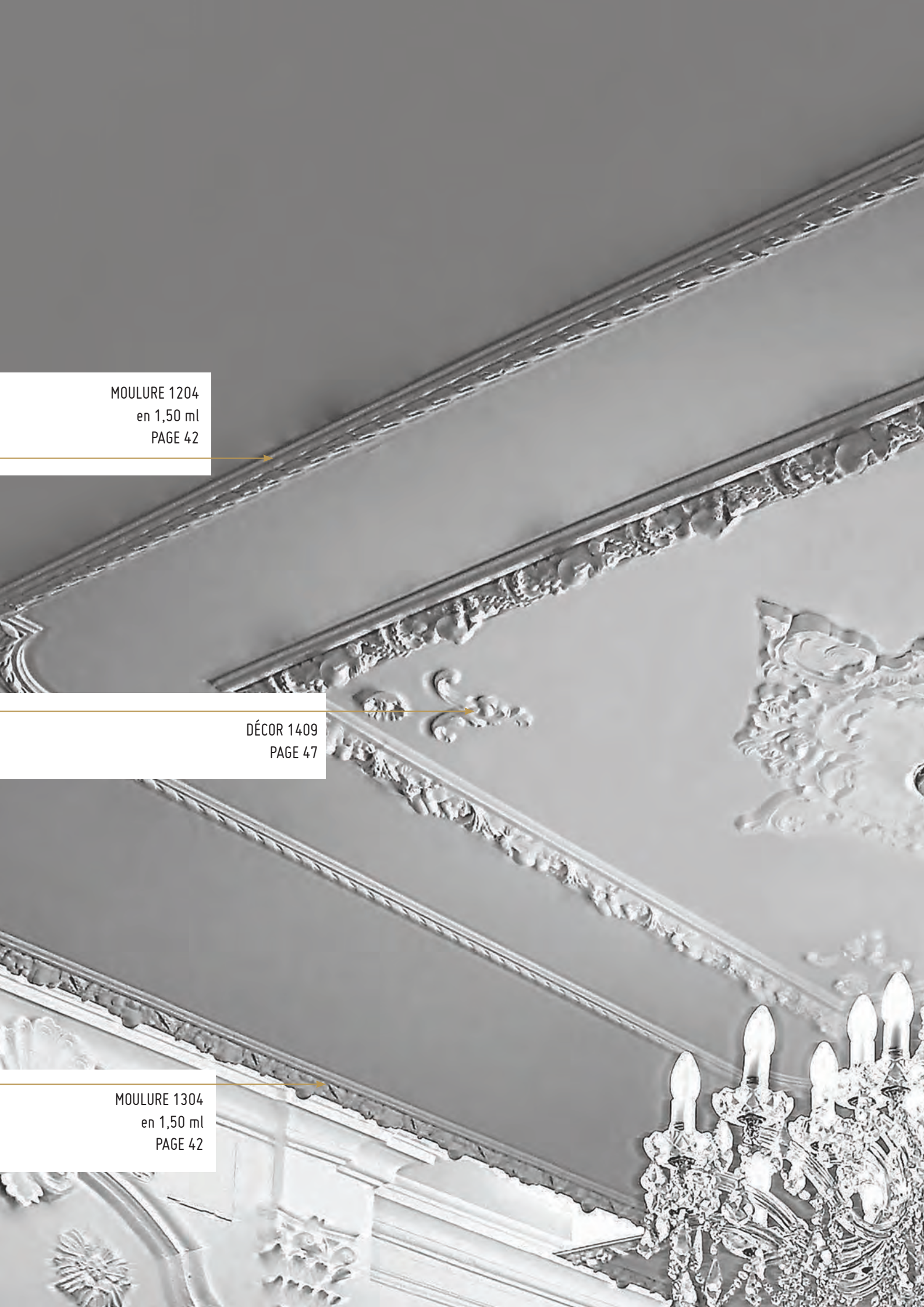

MOULURE 1204
en 1,50 ml
PAGE 42

This image shows a detailed view of a ceiling with multiple layers of decorative moldings. The moldings are intricate, featuring floral and scrollwork patterns. A chandelier with several lit candles is visible in the bottom right corner. Three white callout boxes with black text and orange arrows point to specific moldings: 'MOULURE 1204' points to a top molding, 'DÉCOR 1409' points to a central decorative element, and 'MOULURE 1304' points to a bottom molding.

DÉCOR 1409
PAGE 47

MOULURE 1304
en 1,50 ml
PAGE 42



ANGLE DE MOULURE 1204H
PAGE 47

MOULURE 1303
en 1,50 ml
PAGE 42

ROSACE M071
PAGE 59

LE PLAFOND



	LES CORNICHES	16
	CORNICHES CONTEMPORAINES	18
	CORNICHES À ÉCLAIRAGE INDIRECT	24
	CORNICHES CLASSIQUES	30
	CORNICHES ORNEMENTÉES	34

	LES MOULURES	38
	MOULURES LISSES	40
	MOULURES ORNEMENTÉES	42

	LES ANGLES & DOUCINES DE MOULURES	44
	MOULURES & ANGLES DE MOULURES	46
	DOUCINES	47
	ANGELOTS	47

	LES ROSACES & LES CAISSONS DE PLAFOND	48
	ROSETTES	50
	ROSACES ORNEMENTÉES	51
	ROSACES LISSES	63
	CAISSONS DE PLAFOND	64

	LA COLLECTION ORIENTALE	66
	MOULURES & FRISES	68
	ABAT-JOUR	68
	ROSACES	69
	FRONTONS & CHAPITEAUX	69



CORNICHE D898
en 2 ml
PAGE 34

LES CORNICHES

CORNICHE D575
en 2 ml
PAGE 19

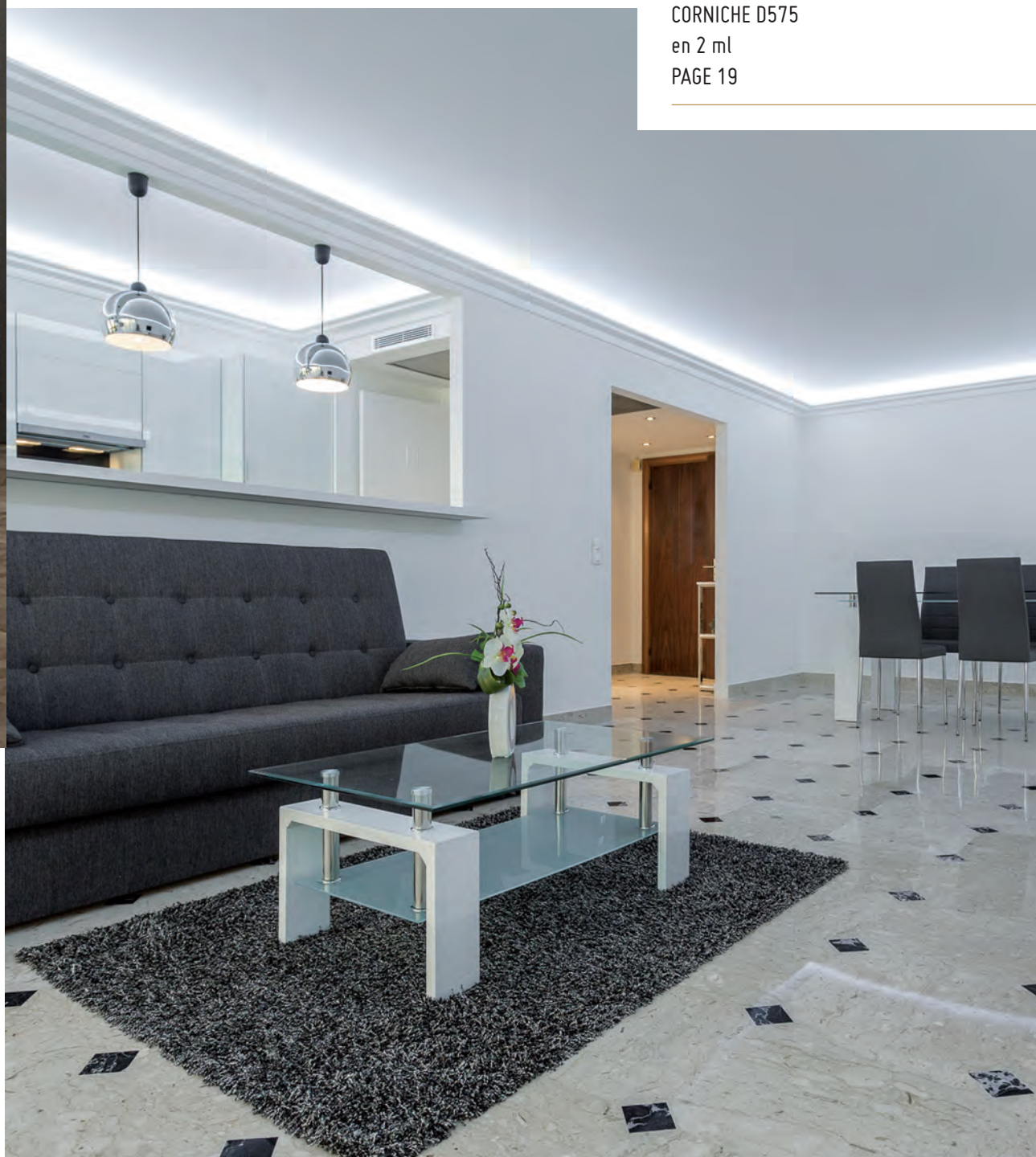

CORNICHES CONTEMPORAINES

D568 (en 2 ml)

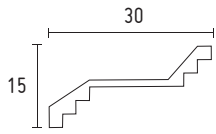

D891 (en 2 ml)

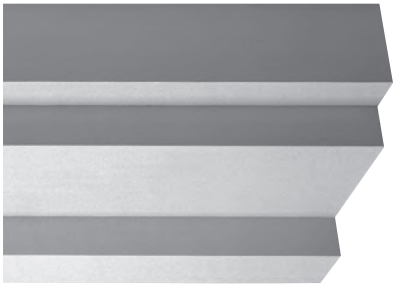
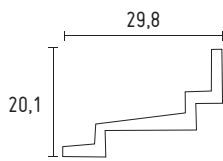

D564 (en 2 ml)

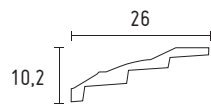

D567 (en 2 ml)

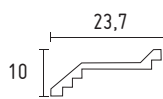

CORNICHE D565
en 2 ml page 19

D577 (en 2 ml)

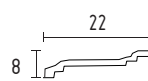

D579 (en 2 ml)

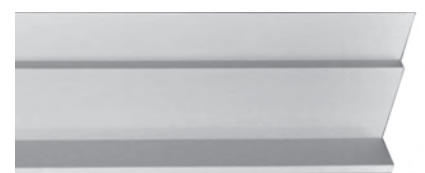
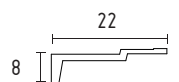

D901 (en 2 ml)

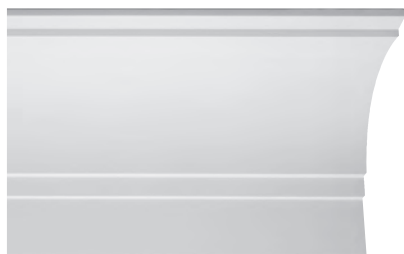
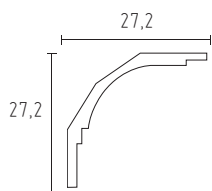

D576 (en 2 ml)



D563 (en 2 ml)

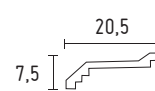

D565 (en 2 ml)

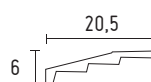

D580 (en 2 ml)



D720 (en 2 ml)

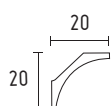

D562 (en 2 ml)

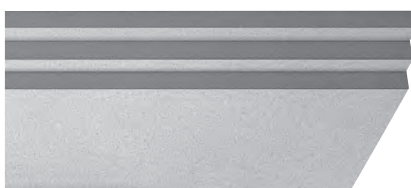
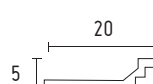

D575 (en 2 ml)

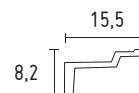

D718 (en 2 ml)

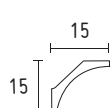

D578 (en 2 ml)

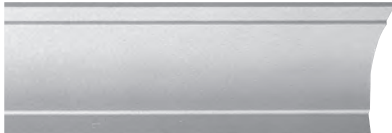
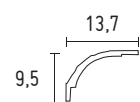

D620 (en 2 ml)



D631 (en 2 ml)



D621 (en 2 ml)

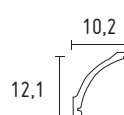

D705 (en 2 ml)

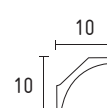

D706 (en 2 ml)

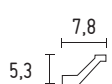

D561 (en 2 ml)



D555 (en 1,50 ml)





POSÉE EN PÉRIPHÉRIE DE LA PIÈCE, LA DEMI-VAGUE SERPENTE LE LONG DES PLAFONDS POUR EN ADOUCIR LES ANGLES.

VAGUE DE SÉPARATION avec corniche D577 intégrée

Ce décor de plafond préfabriqué monobloc en forme permet de créer au sein d'une grande pièce deux espaces distincts. Par exemple, il assurera la séparation entre le coin séjour et le coin salon.

- > Largeur avec corniche : 104 cm
 - > Largeur de la plage : 60 cm
 - > Longueur sur mesure (possibilité jusqu'à 6 mètres, livrés en plusieurs éléments si nécessaire en fonction des contraintes d'accessibilité)
 - > La retombée de 8 cm permet de repenser l'éclairage de la pièce par l'installation de spots.
- Il est préférable de réaliser les trous de réservation pour les spots lors de la fabrication de l'élément.



Face intérieure du moulage faisant apparaître les renforts métalliques de type F530 qui pourront être utilisés pour la fixation au plafond de la vague.

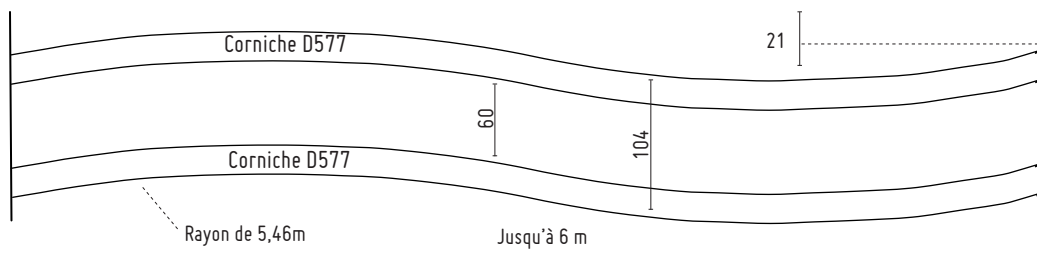
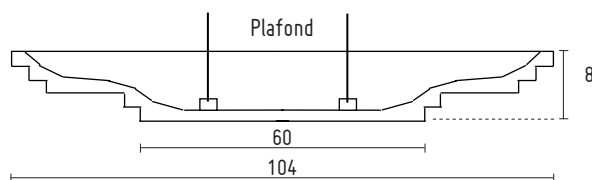

CORNICHE EN VAGUE

Ce décor de plafond associe sur un même moulage une plage horizontale d'une largeur variable jusqu'à 67 cm pour la référence SV577 et 83 cm pour la SV748 et une corniche dont les ondulations régulières forment des vagues qui se propagent le long des murs.

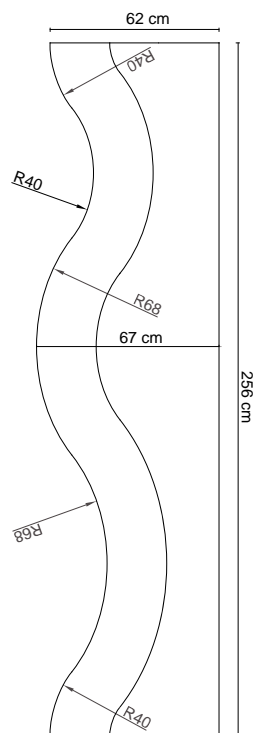

POSÉE DIRECTEMENT AU PLAFOND, LA VAGUE RÉF. SV577 PERMET D'INTÉGRER UN ÉCLAIRAGE PAR SPOTS.

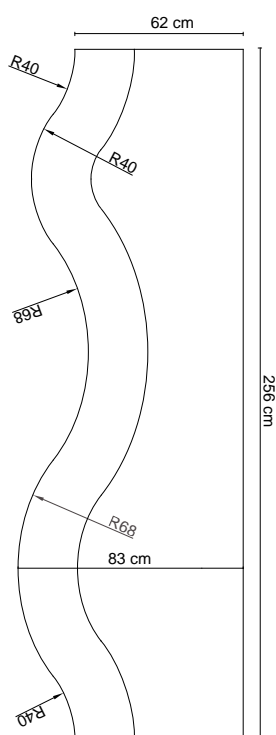

POSÉE À 10 CM ENVIRON DU PLAFOND, LA CORNICHE EN VAGUE RÉF. SV748 CONSTITUE ÉGALEMENT LE SUPPORT ORIGINAL D'UN ÉCLAIRAGE INDIRECT.

LA CORNICHE S908

Le profil de cette corniche peut être fabriqué en un seul élément présentant une avancée sur le plafond de 90 cm et une longueur pouvant atteindre 290 cm. La réalisation de ce décor de plafond en staff traditionnel aurait conduit à poser, assembler et jointoyer sur le chantier deux corniches distinctes reliées entre elles par une plage horizontale de 51 cm en staff ou en plaque de plâtre. Ce profil S908 est fixé mécaniquement par vissage sur ossatures fixées sur le mur et sur le plafond, ce qui simplifie la mise en œuvre et en réduit substantiellement les délais d'exécution.

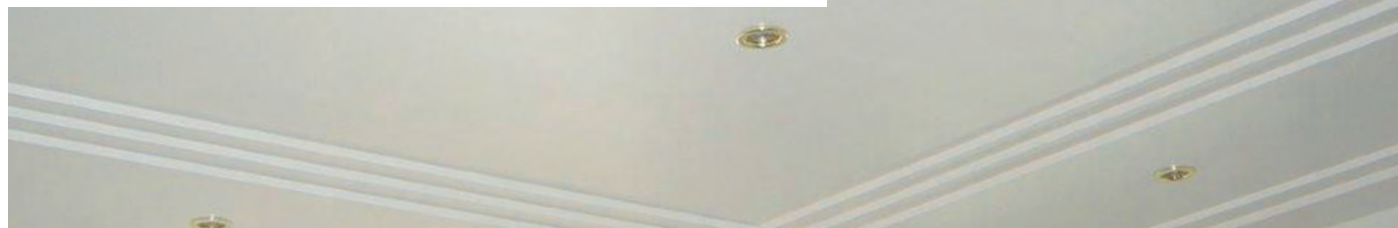
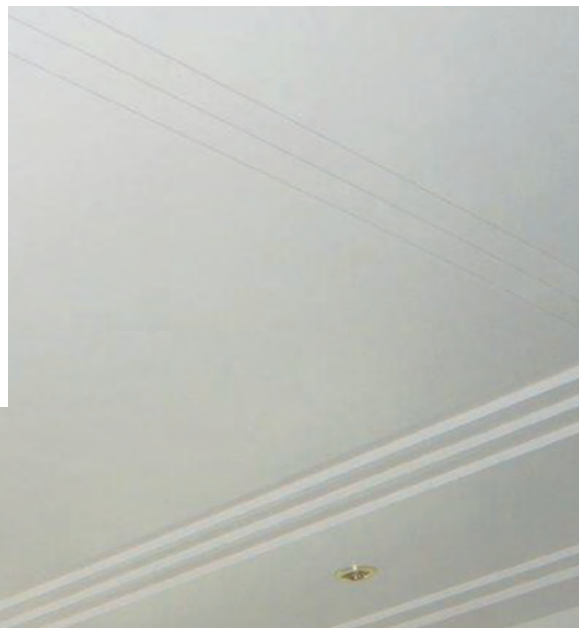

Pour composer ce plafond, il vous faudra intégrer deux éléments distincts :

> L'élément d'angle Réf S908A

> L'élément de côté Réf S908

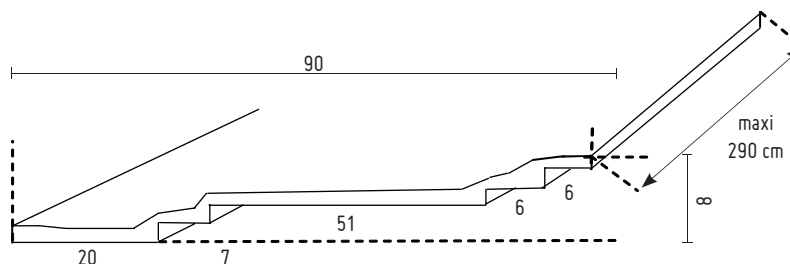
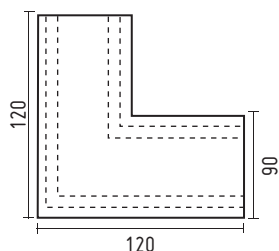

Les éléments de côté sont fabriqués selon un plan de calepinage établi sur la base des dimensions du plafond. Le poids de cet ensemble sera d'environ 9 à 10 kg/m².

LES AVANTAGES

- > Installation très rapide, les éléments s'emboîtent les uns dans les autres.
- > Conservation de la hauteur sous-plafond.
- > Possibilité d'installer un éclairage direct ou indirect.
- > Les moulages sont préparés pour faciliter leur montage.

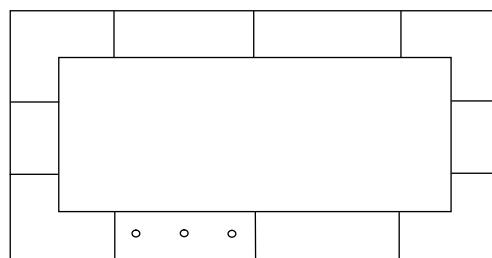

Mise en œuvre simple par vissage

> Montage classique avec spot

> Montage en éclairage indirect (équerre en supplément)

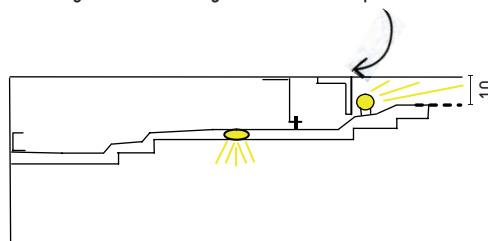
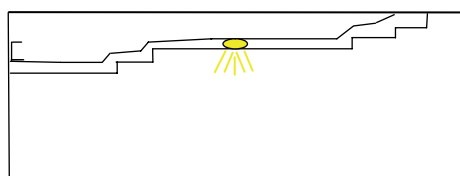

DÉCORS DE PLAFOND EN «U»

Ce décor de plafond tout en sobriété est composé d'éléments en forme de «U» et de 2,50 ml de long. Disponible en 2 hauteurs (7 cm ou 10 cm) selon l'encombrement des luminaires à intégrer dans la partie centrale surépaissie. Il est mis en oeuvre par simple vissage sur tasseaux. Ces décors sont réalisés en Stratistaff (staff aminci). Vous pouvez retrouver l'ensemble de nos profils "U" en staff traditionnel à la page 160.

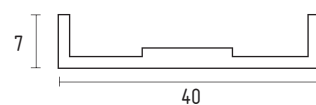

Réf. US0740 (en 2,50 ml)

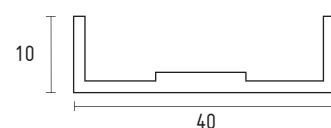

Réf. US1040 (en 2,50 ml)

Montée en soffite, cet élément décoratif redessine les espaces et permet l'installation de nouveaux éclairages tout en dissimulant le passage des gaines électriques.

JOINTS CREUX

Les joints creux sont fournis en longueur de 2 ml.

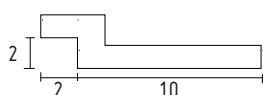

JC22.10

Joint creux 2 + 2 + 10 cm, ep. 1,5 cm

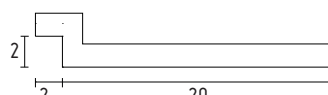

JC22.20

Joint creux 2 + 2 + 20 cm, ep. 1,5 cm

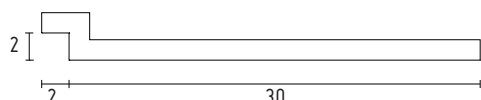

JC22.30

Joint creux 2 + 2 + 30 cm, ep. 1,5 cm

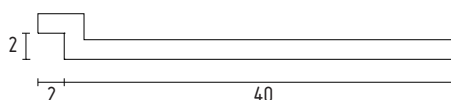

JC22.40

Joint creux 2 + 2 + 40 cm, ep. 1,5 cm

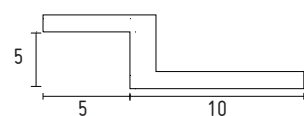

JC55.10

Joint creux 5 + 5 + 10 cm, ep. 1,5 cm

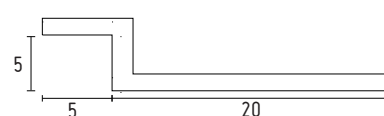

JC55.20

Joint creux 5 + 5 + 20 cm, ep. 1,5 cm



CORNICHES À ÉCLAIRAGE INDIRECT

D710 (en 2 ml)

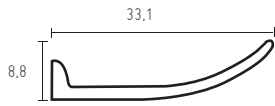

D748 (en 2 ml)

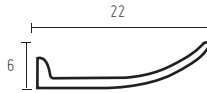

D749 (en 2 ml)

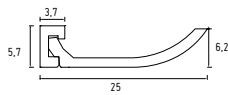

D708 (en 2 ml)

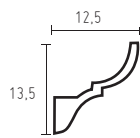

D709 (en 2 ml)

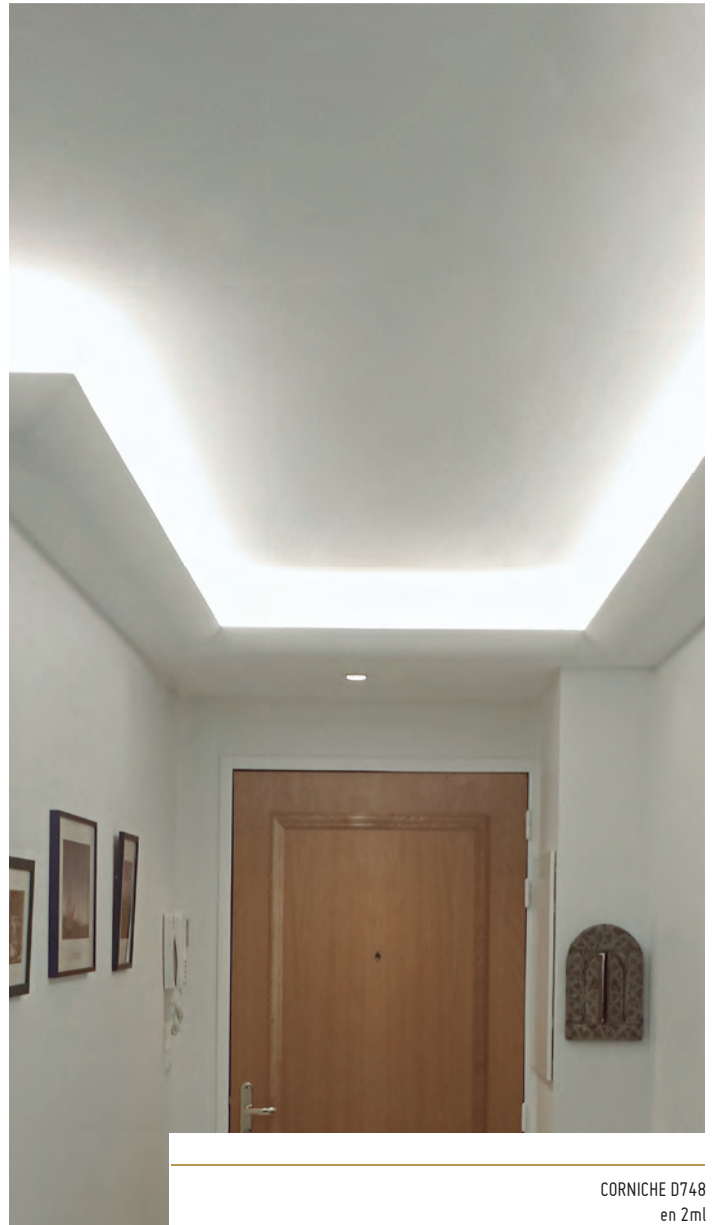
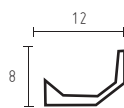

CORNICHE D748
en 2ml

SCHEMA DE PRINCIPE D709

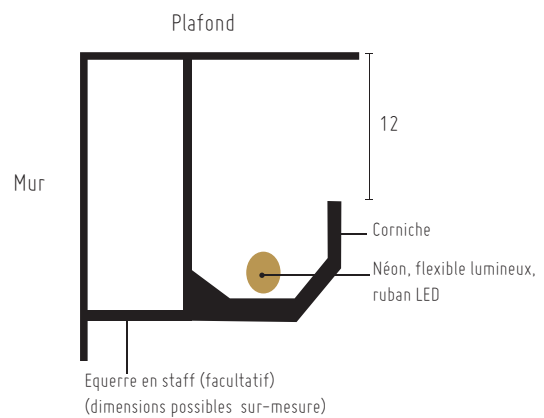

D101 (en 2 ml)

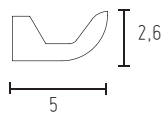

D105 A & B (en 2 ml)

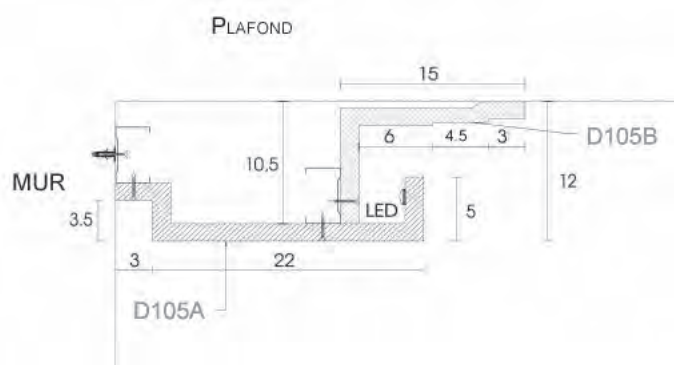

D102 (en 2 ml)

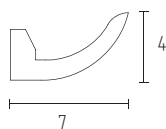

D103 (en 2 ml)

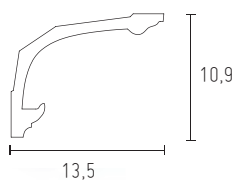

D104 (en 2 ml)

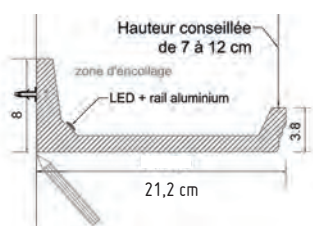

CORNICHE D105A
en 2ml

CORNICHES À ÉCLAIRAGE INDIRECT

D105A (en 2 ml)

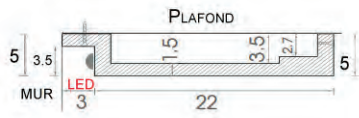

D106 (en 2 ml)

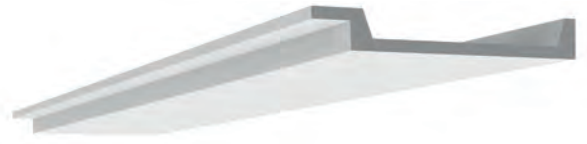
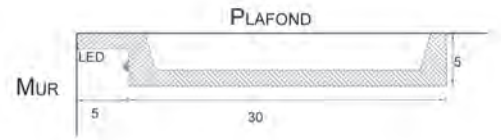

D108 (en 2 ml)

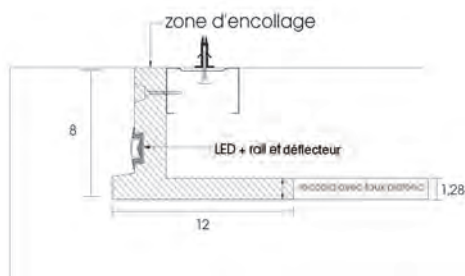

D107 (en 2 ml)

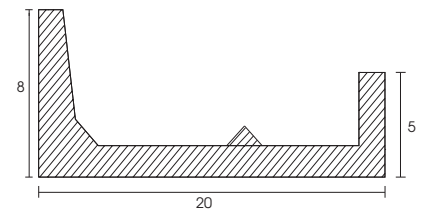

D110 (en 2 ml)

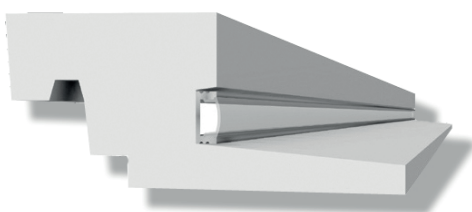
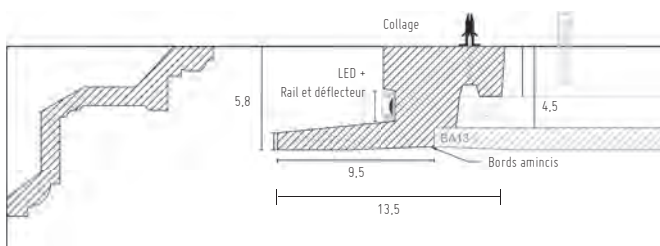

PROFILS LUMINEUX COMPOSABLES

EMB95 (en 2 ml) > 9,7 x 4 cm
 EBL0430 (en 2 ml) > 30 x 4 cm

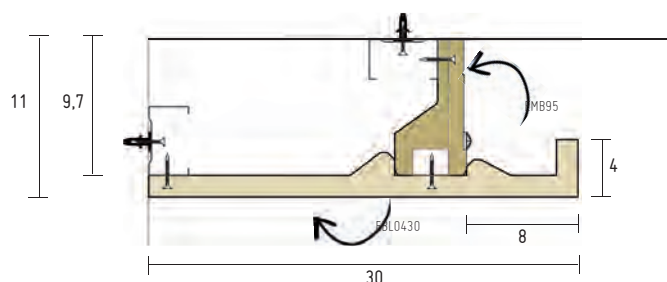

PROFILS LUMINEUX COMPOSABLES

Les bandeaux lumineux sont des profils pouvant se poser en relief ou à fleur de vos murs et plafonds.

BL120 (en 2 ml)

Profil à associer à un rail en aluminium avec déflecteur en polycarbonate et un flexible LED.

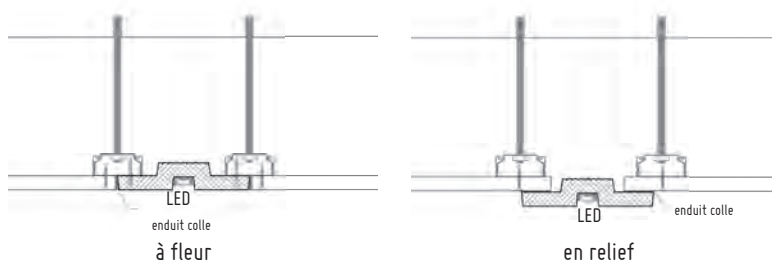
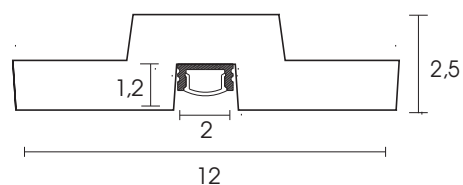

CORNICHES À ÉCLAIRAGE INDIRECT

BL130 (en 2,6 ml)
7 x 5 cm

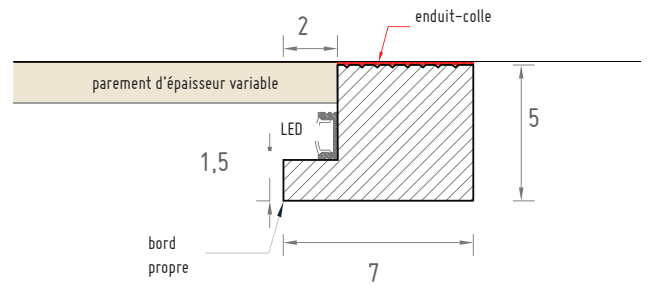

BL131 (en 2,5 ml)
10 x 7 cm

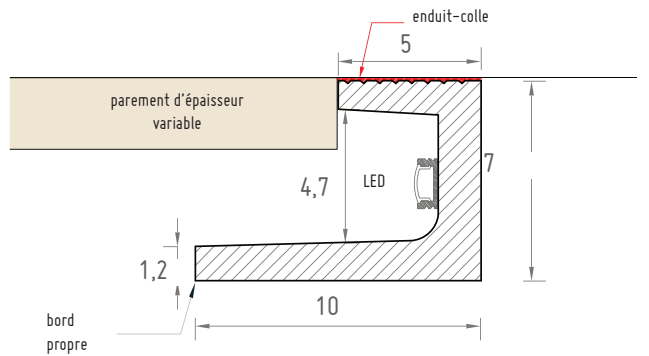

BL132 (en 2,5 ml)
8 x 5,5 cm

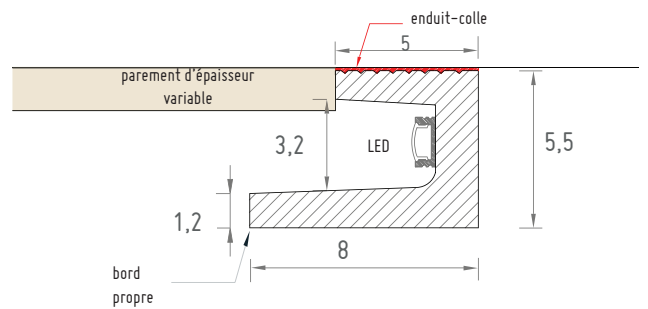
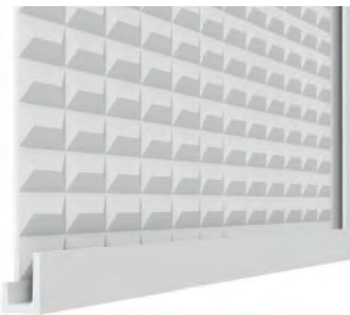

BL140 (en 2,8 ml)
8 x 4 cm

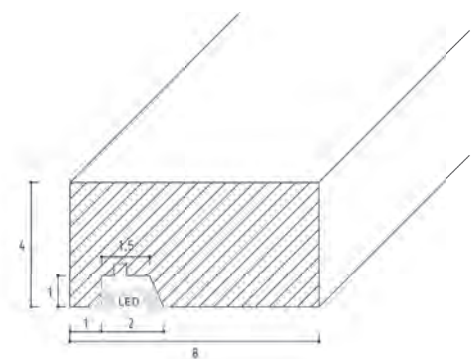

BL160 (en 2 ml)
19 x 6 cm

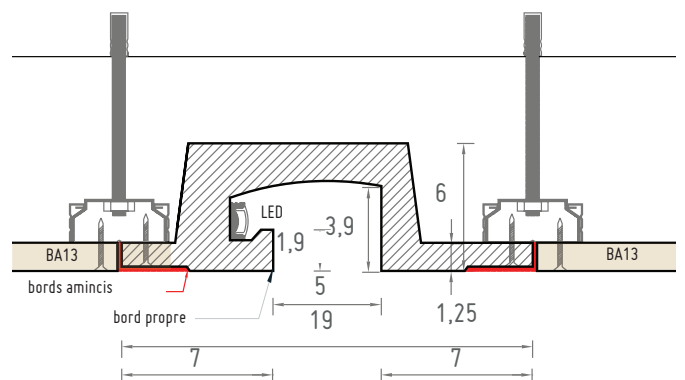
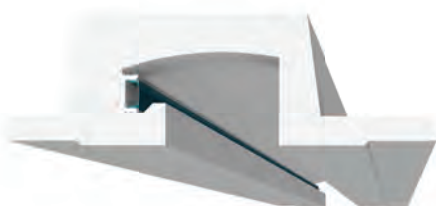

BL170 (en 2 ml)
19,5 x 4,7 cm

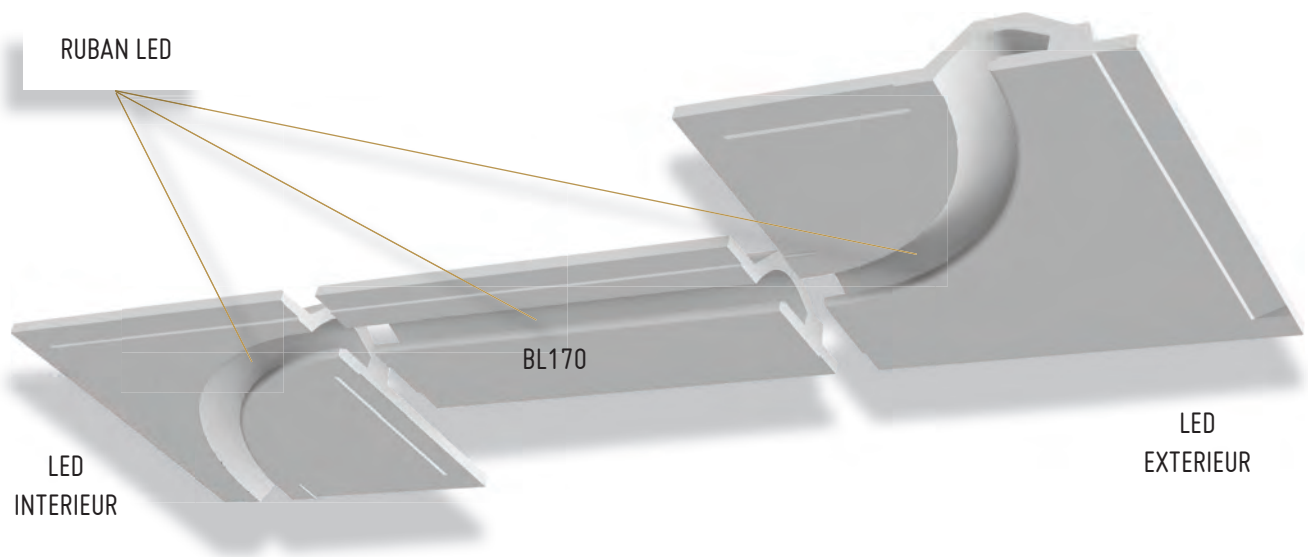
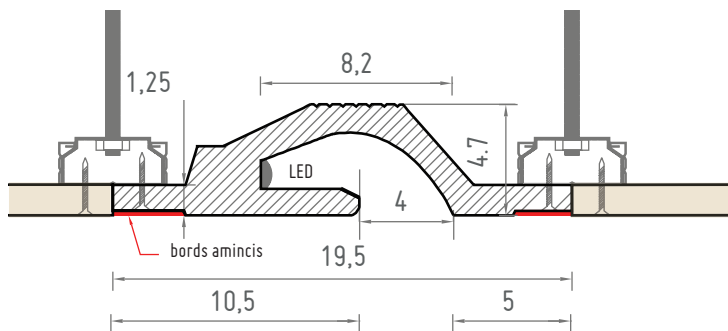

BL170
en 2 ml

BL170R25I

Gorge lumineuse cintrée de
25 cm de rayon Led Intérieur
34 x 34 cm

BL170R25E

Gorge lumineuse cintrée de
25 cm de rayon Led Extérieur
35,5 x 35,5 cm

BL170R50I

Gorge lumineuse cintrée de
50 cm de rayon Led Intérieur
59 x 59 cm

BL170R50E

Gorge lumineuse cintrée de
50 cm de rayon Led Extérieur
60,5 x 60,5 cm

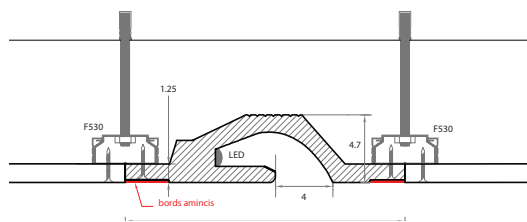

LED INTERIEUR

LED EXTERIEUR

D892 (en 2 ml)

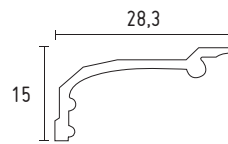

D560 (en 2 ml)

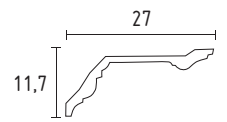

D900 (en 2 ml)

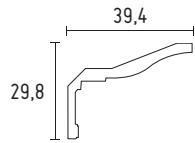

D802 (en 2 ml)

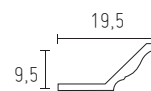

D601 (en 2 ml)

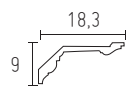

Le saviez-vous ?

Toutes nos corniches contemporaines, classiques et ornementées peuvent être cintrées !

Confiez-nous vos plans et gabarits. Renseignez-vous auprès de votre agence Staff Décor et réalisons vos projets !



CORNICHE D801
en 2 ml
PAGE 33
© Château Mader

D605 (en 2 ml)

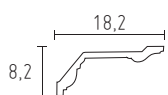

D609 (en 2 ml)

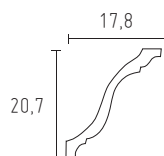

D626 (en 1,75 ml)

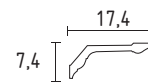

D574 (en 2 ml)

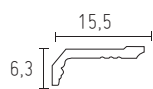

D608 (en 2 ml)

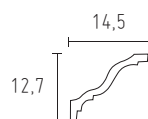

D830 (en 2 ml)

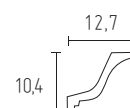

D611 (en 1,75 ml)

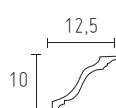

D604 (en 2 ml)

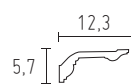

D545 (en 1,75 ml)



D612 (en 2 ml)



D614 (en 1,75 ml)

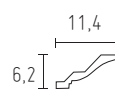

D625 (en 1,75 ml)

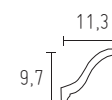

D610 (en 1,75 ml)

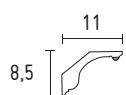

D707 (en 2 ml)

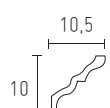

D630 (en 1,75 ml)



D704 (en 2 ml)



D520 (en 1,75 ml)



D703 (en 1,75 ml)



CORNICHES CLASSIQUES

ÉCOINÇON DE CORNICHE D880A

Angle : 80 x 80 cm

Hauteur : 18 cm

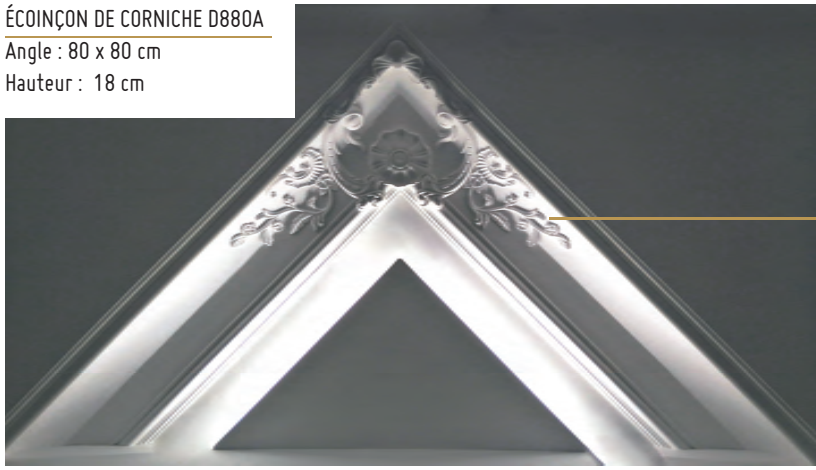

D880 (en 2 ml)

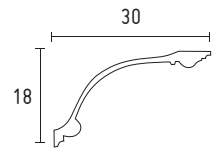

D654 (en 2 ml)

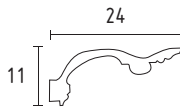

D651 (en 2 ml)

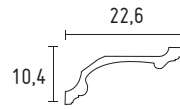

D652 (en 2 ml)

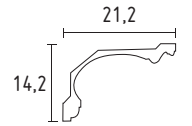

D650 (en 2 ml)

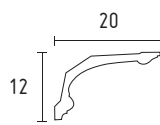

D606 (en 2 ml)

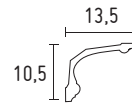

D624 (en 1,75 ml)



D616 (en 1,75 ml)

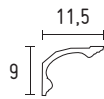

D607 (en 2 ml)

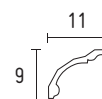

D702 (en 1,75 ml)

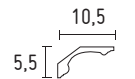

D623 (en 1,75 ml)

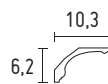

D622 (en 1,75 ml)

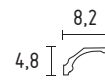

Pour les corniches D601, D606, D611, D616, D702, D707, vous pouvez leur associer un angle rentrant et sortant (par exemple, R601 et S601 pour la corniche D601...).

Angle rentrant
R702

Angle sortant
S702





CORNICHE D650
PAGE 32

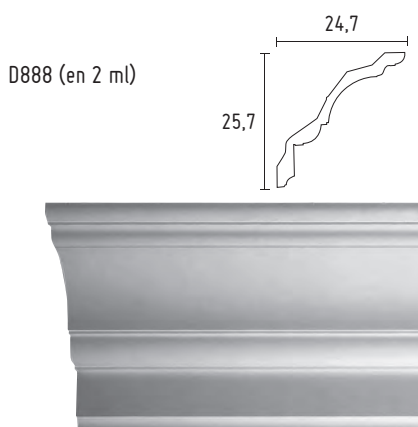
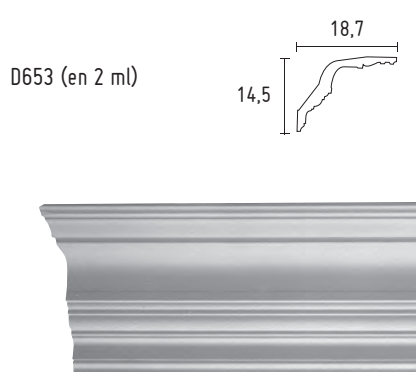
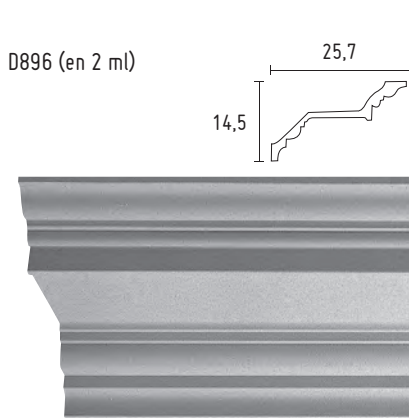
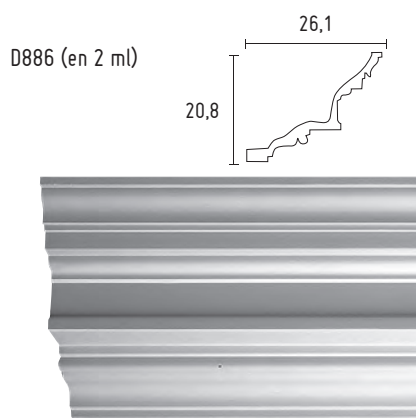

*Corniches pour
grande
hauteur
sous plafond !*

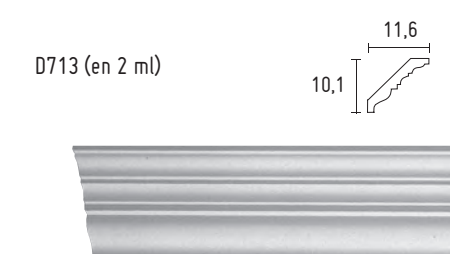
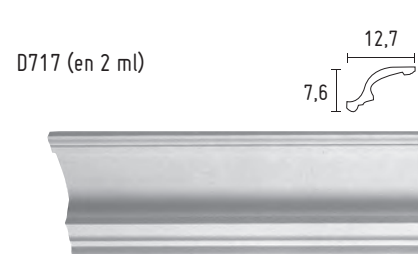
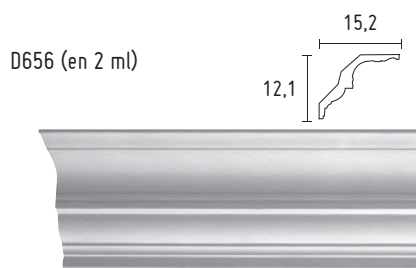
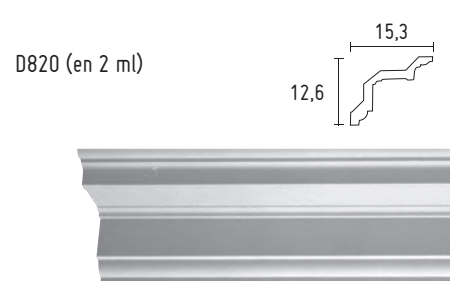
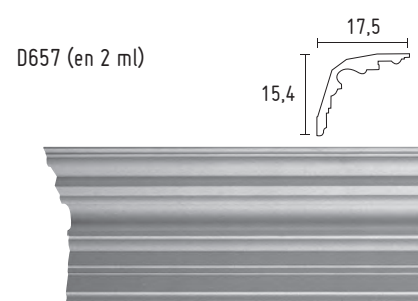
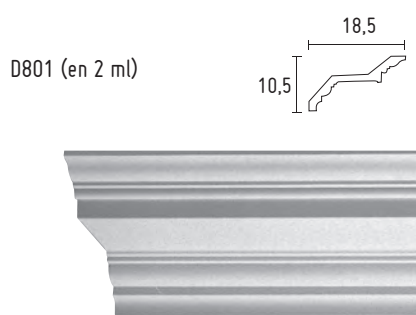

CORNICHES ORNEMENTÉES

D899 (en 2 ml)

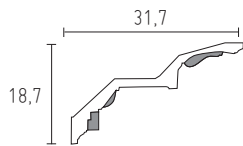

D898 (en 2 ml)

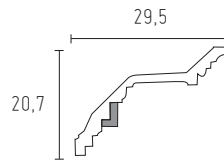

D889 (en 2 ml)

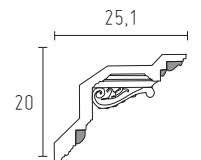

D815 (en 2 ml)

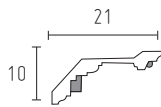

D814 (en 2 ml)

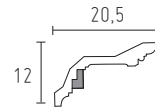

D569 (en 2 ml)

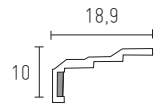

D810
(en 2 ml)

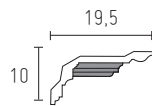

D515 (en 2 ml)

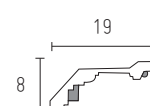

D902 (en 2 ml)

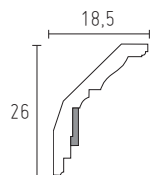

D628 (en 2 ml)

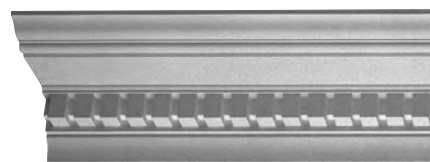
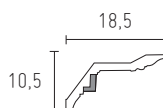

D629 (en 2 ml)

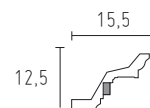

D531 (en 2 ml)

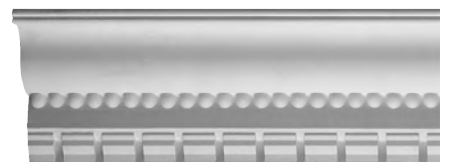
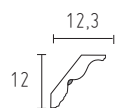

D840 (en 2 ml)

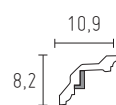

D715 (en 1,75 ml)

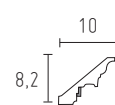

D617 (en 1,75 ml)

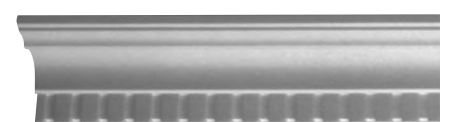
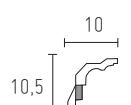

D897 (en 2 ml)

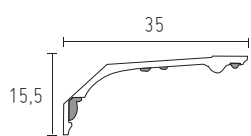

D895 (en 2 ml)

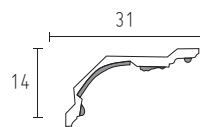

D885 (en 2 ml)

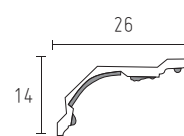

D894 (en 2 ml)

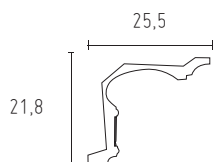

D893 (en 2 ml)

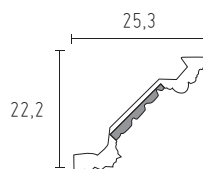

D884 (en 2 ml)

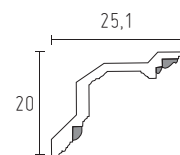

D844 (en 2 ml)

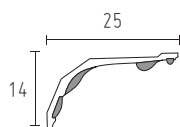

D570 (en 2 ml)



D566 (en 2 ml)

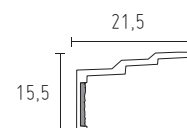

D843 (en 2 ml)

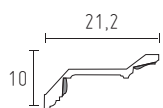

D813 (en 2 ml)

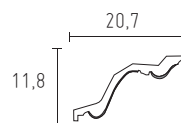

D510 (en 2 ml)

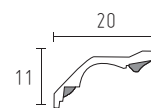

D812 (en 2 ml)



D505 (en 2 ml)

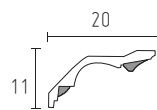

D845 (en 2 ml)

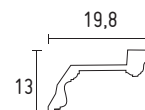

CORNICHES ORNEMENTÉES

D846 (en 2 ml)

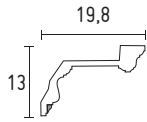

D627 (en 2 ml)

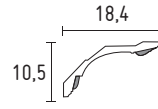

D716 (en 2 ml)

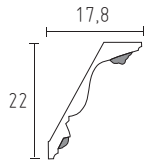

D835 (en 2 ml)

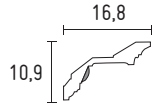

D818 (en 2 ml)

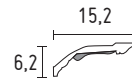

D712 (en 2 ml)

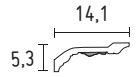

D615 (en 1,75 ml)

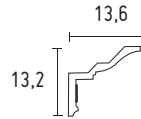

D655 (en 2 ml)

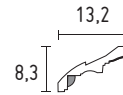

D530 (en 2 ml)

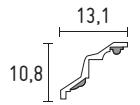

D513 (en 1,75 ml)

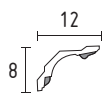

D525 (en 1,75 ml)



D535 (en 1,75 ml)



D711 (en 2 ml)

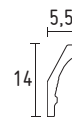

D540 (en 1,75 ml)



D550 (en 1,50 ml)



D890 (en 2 ml)

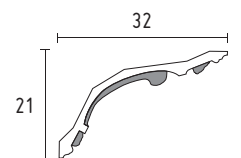

ÉCOINÇON DE CORNICHE D890A

Angle : 80 x 80 cm
Hauteur : 21cm



Feuilles d'angle pour corniches

(Pour réf. D505, D510, D601)



R561



S562

PLAQUES COFFRE

Vendues en longueur de 1,5 ml

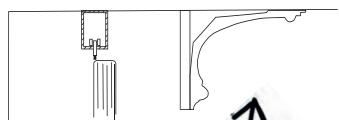

Les petits + de nos plaques coffre :

X Pour les finitions impeccables de vos coffres à rideaux associés à une corniche.

X Pour que vos corniches courent idéalement sur les trémies de vos escaliers.

X Pour faciliter la pose de vos parements !

- C080
Plaque coffre haut.80 mm
- C090
Plaque coffre haut.90 mm
- C0100
Plaque coffre haut.100 mm
- C0105
Plaque coffre haut.105 mm
- C0110
Plaque coffre haut.110 mm
- C0120
Plaque coffre haut.120 mm



Nos plaques coffre peuvent également être réalisées sur mesure dans nos ateliers (hauteur variable).

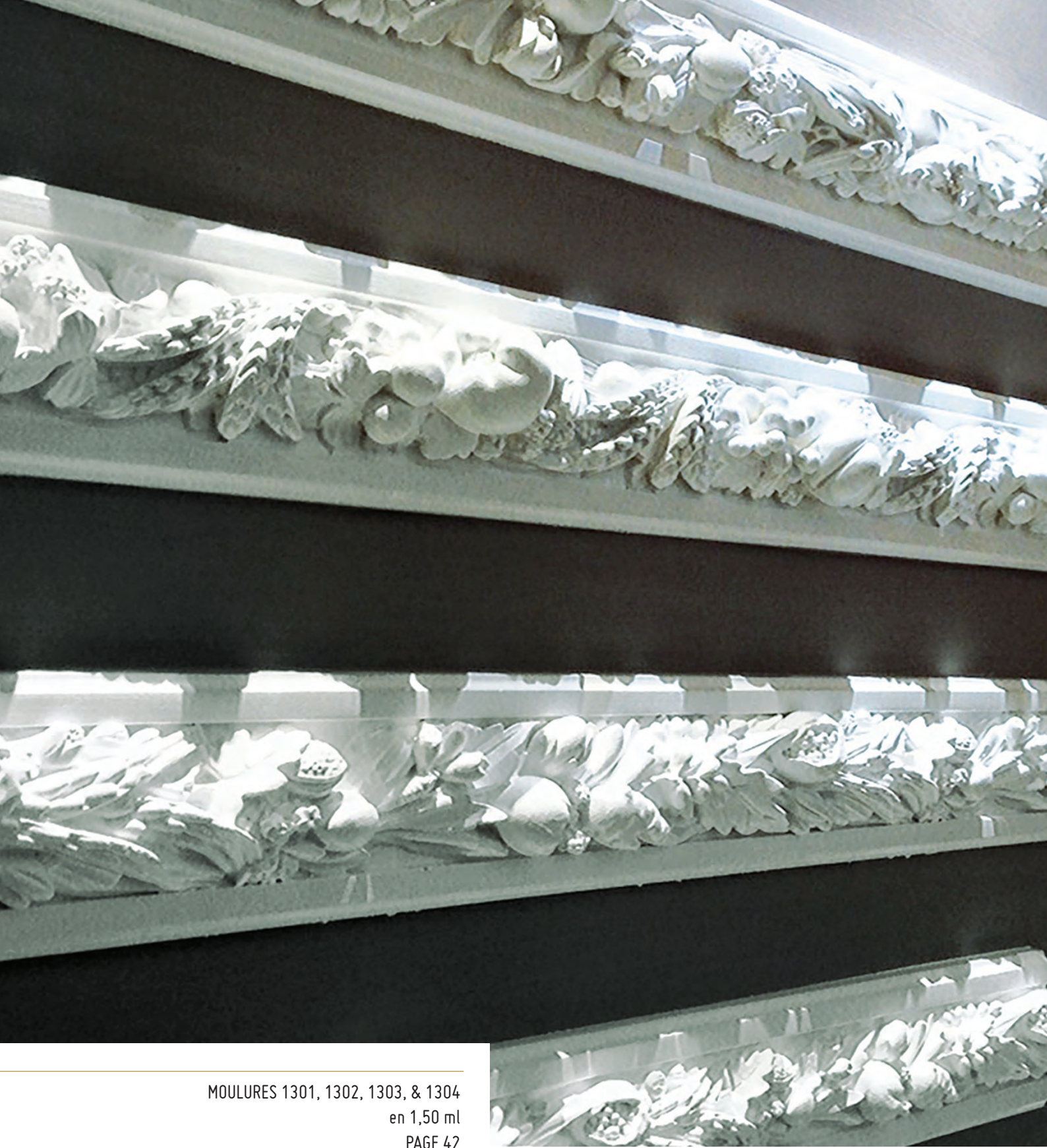

MOULURES 1301, 1302, 1303, & 1304
en 1,50 ml
PAGE 42

LES MOULURES

MOULURE 1345
en 2 ml
PAGE 40
© Château Mader

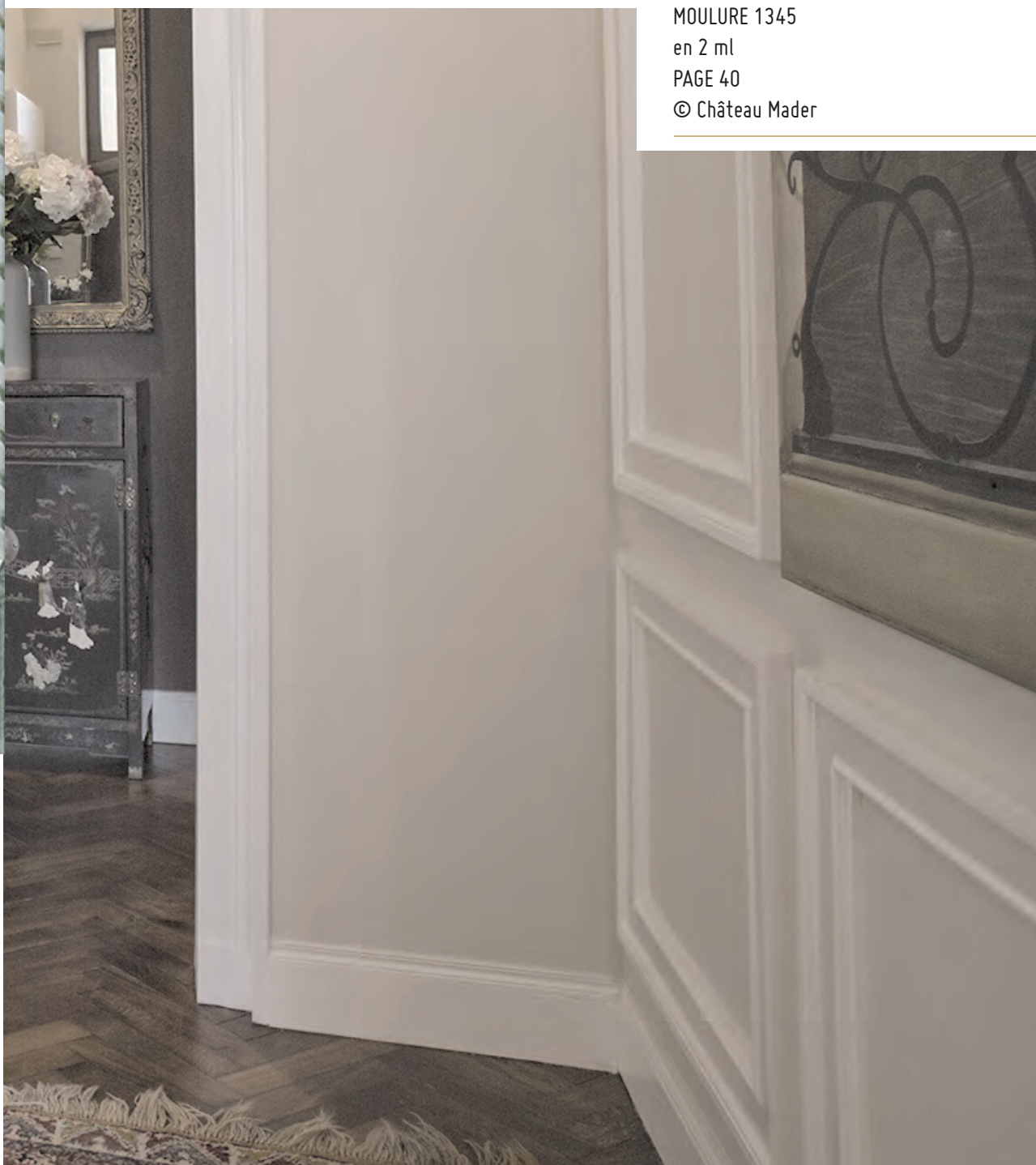

MOULURES LISSES

1365 (en 1,75 ml)



1108 (en 2,15 ml)



1125 (en 2,15 ml)



1364 (en 2,15 ml)



1130 (en 2,15 ml)



1155 (en 1,50 ml)



1367 (en 2,15 ml)



1202 (en 1,50 ml)



1343 (en 1,50 ml)



1324 (en 2 ml)



1120 (en 2,15 ml)



1206 (en 1,50 ml)



1366 (en 2,15 ml)



1124 (en 2,15 ml)



1200 (en 1,50 ml)



1201 (en 1,50 ml)



1121 (en 2,15 ml)



1210 (en 1,75 ml)



1101 (en 1,50 ml)



1166 (en 1,50 ml)



1107 (en 1,50 ml)



1102 (en 1,50 ml)



1344 (en 1,50 ml)



1207 (en 1,50 ml)



1103 (en 1,50 ml)



1156 (en 1,50 ml)



1380 (en 1,50 ml)



1209 (en 1,75 ml)



1345 (en 2 ml)



Retrouvez nos moulures de 2,15 ml (couvre-joints) page 106 !

MOULURE 1101
en 1,50 ml
PAGE 40



Le saviez-vous ?



Toutes nos moulures contemporaines, classiques et ornementées peuvent être cintrées ! Confiez-nous vos plans et gabarits. Renseignez-vous auprès de votre agence Staff Décor et réalisons vos projets !

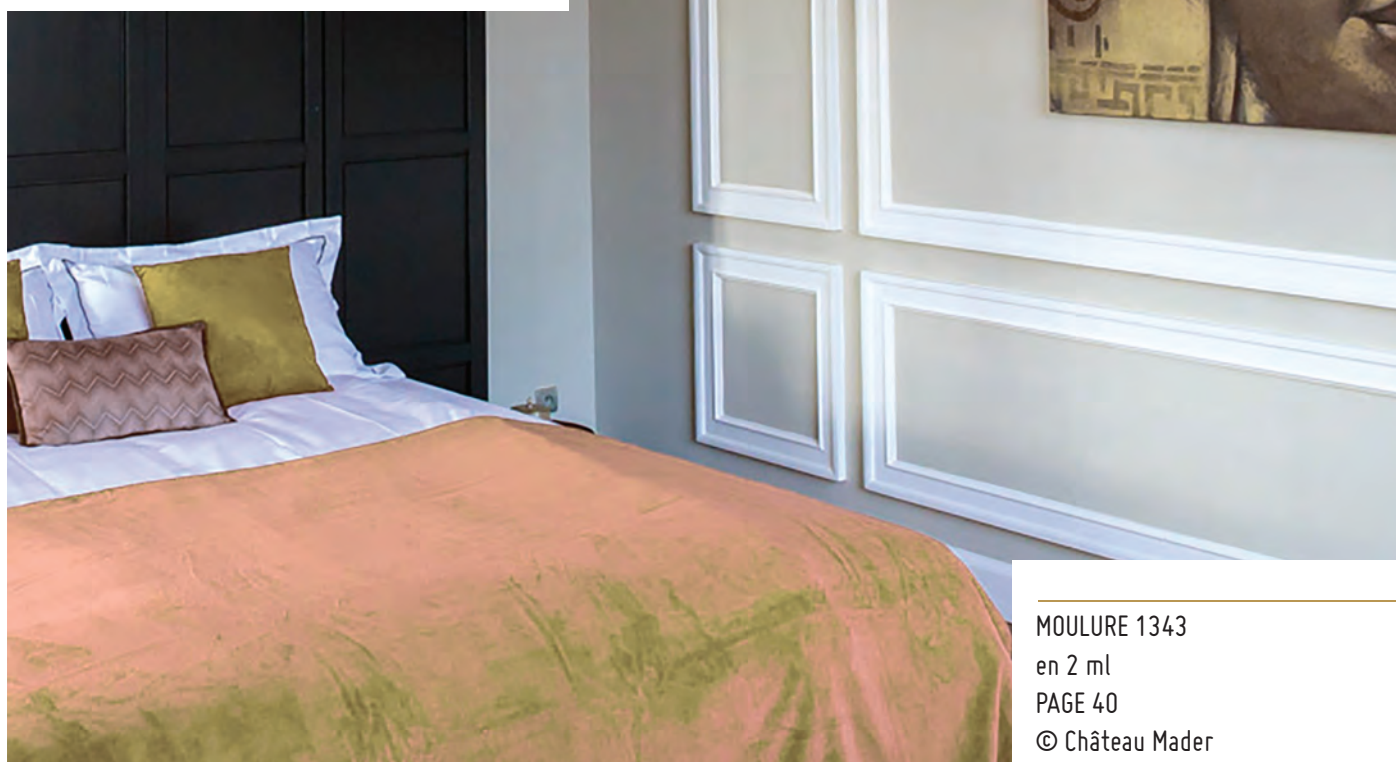

MOULURE 1343
en 2 ml
PAGE 40
© Château Mader

MOULURES ORNEMENTÉES

1208 (en 1,50 ml)



3,5

1110 (en 1,25 ml)



10,7

1111 (en 1,35 ml)



11,5

1112 (en 1,15 ml)



19,5

1113 (en 1,65 ml)



8,5

1205 (en 1,25 ml)



8,5

1104 (en 1,50 ml)



6

1105 (en 1,50 ml)



6

1106 (en 1,50 ml)



6,8

1109 (en 1,50 ml)



4,5

1114D ou 1114G (en 1,50 ml)



5,2

1204 (en 1,50 ml)



4

1157 (en 1,50 ml)



3

1150 (en 1,55 ml)



1151 (en 1,65 ml)



1301 (en 1,50 ml)

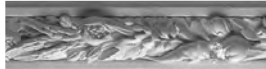

1302 (en 1,50 ml)



1303 (en 1,50 ml)



1304 (en 1,50 ml)



1305 (en 1,50 ml)



1306 (en 1,50 ml)



1310 (en 1,50 ml)



1321 (en 1,50 ml)



1322 (en 1,50 ml)



1323 (en 1,50 ml)



1325 (en 1,50 ml)



1326 (en 1,50 ml)



1327 (en 2,00 ml)



1328 (en 1,75 ml)



1329 (en 1,50 ml)



1330 (en 1,50 ml)



1331 (en 1,50 ml)



1332 (en 1,70 ml)



1333 (en 1,50 ml)



1340 (en 1,80 ml)



1374 (en 1,25 ml)

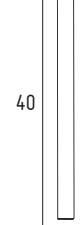
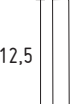
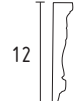
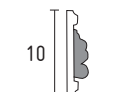
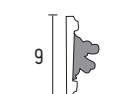
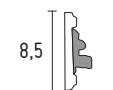
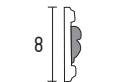
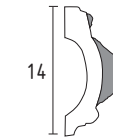

1341 (en 1,50 ml)

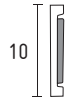

1342 (en 1,80 ml)

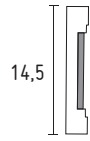

1346 (en 1,50 ml)



1347 (en 1,50 ml)



1348 (en 1,50 ml)



1349 (en 1,50 ml)



1203 (en 2 ml)



1334 (en 2 ml)



1335 (en 2 ml)

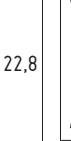

1371 (en 1,80 ml)



1320 (en 1,50 ml)



1373 (en 1,70 ml)



1372 (en 1,70 ml)

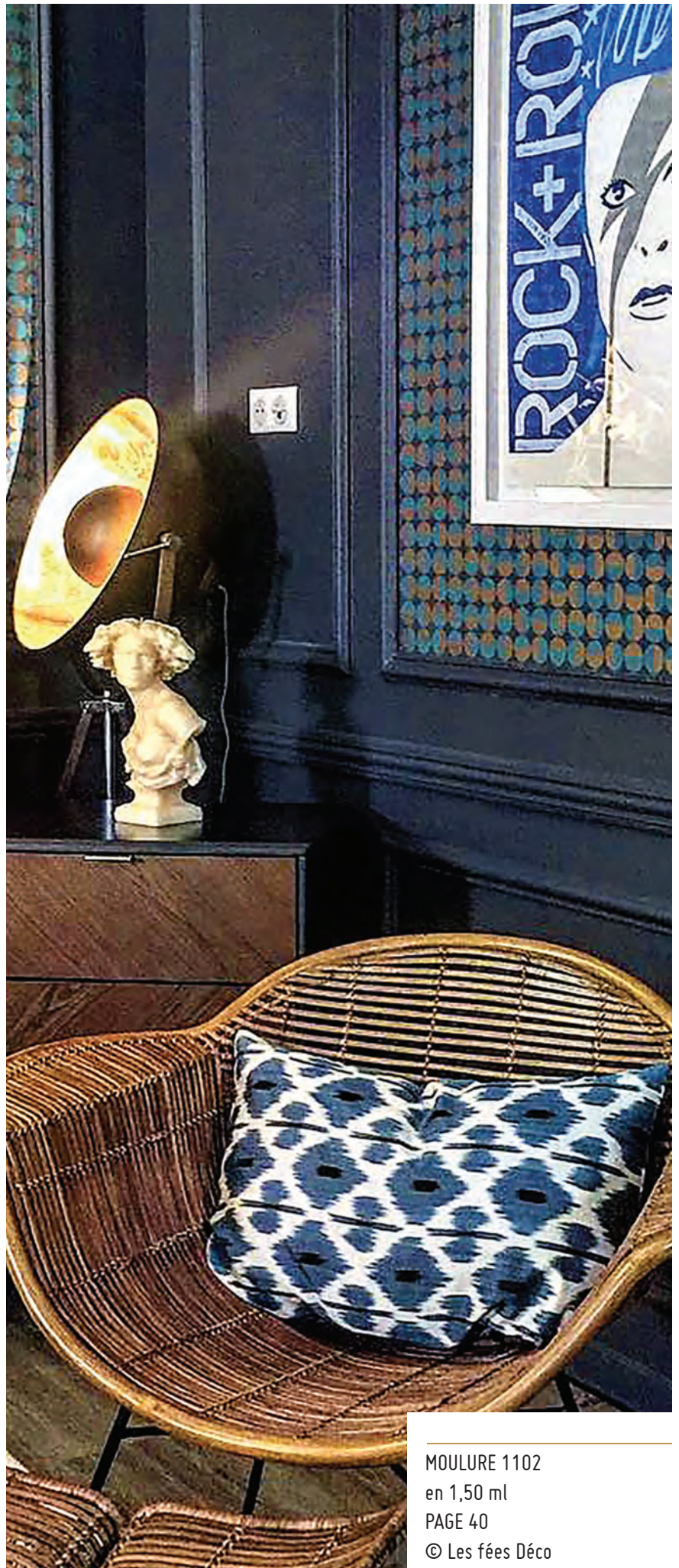

MOULURE 1102
en 1,50 ml
PAGE 40
© Les fées Déco



ANGLE 1103D
PAGE 46



LES ANGLES & DOUCINES DE MOULURES

ANGLE 1204H

PAGE 47

© Hôtel Victor Hugo, Pontorson.



ANGLES & DOUCINES DE MOULURES

1150 (en 1,55 ml)

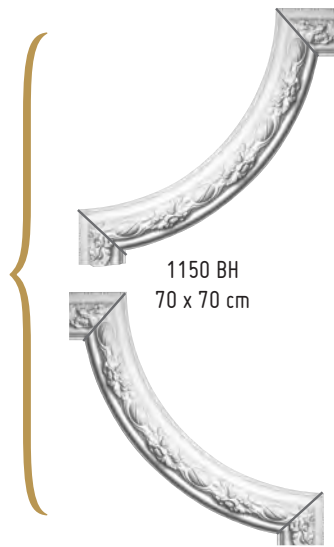

1151 (en 1,65 ml)

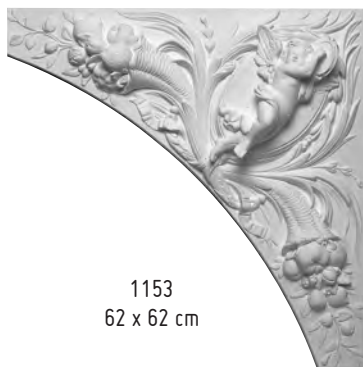
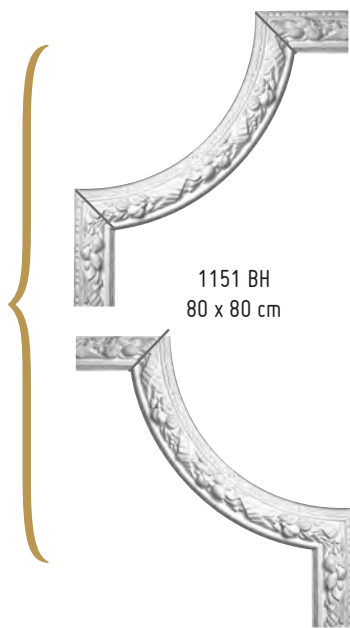

1153
62 x 62 cm

1104 (en 1,50 ml)



1104 H
37 x 25,5 cm



1104 B
23 x 23 cm



1105 (en 1,50 ml)



1105H
37 x 25,5 cm



1105 B
23 x 23 cm

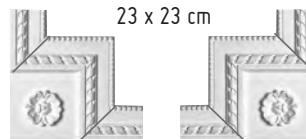

1200 (en 1,50 ml)

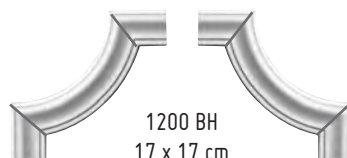

1200 BH
17 x 17 cm

1103 (en 1,50 ml)

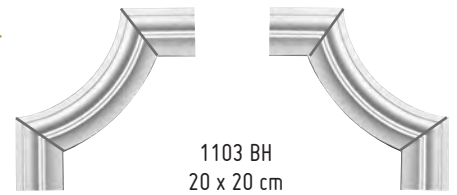

1103 BH
20 x 20 cm

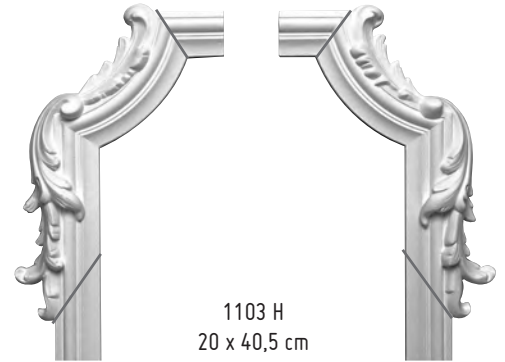

1103 H
20 x 40,5 cm

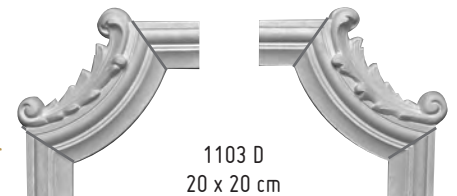

1103 D
20 x 20 cm

1210 (en 1,75 ml)



1210 BH
50 x 50 cm

1206 (en 1,50 ml)

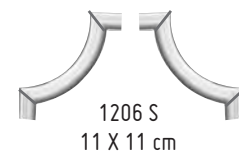

1206 S
11 X 11 cm



1206 R
11 X 11 cm

1204 (en 1,50 ml)

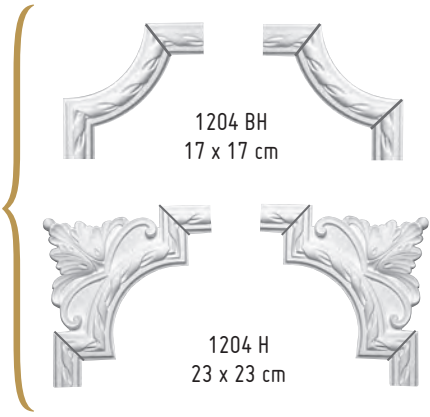

1102 (en 1,50 ml)

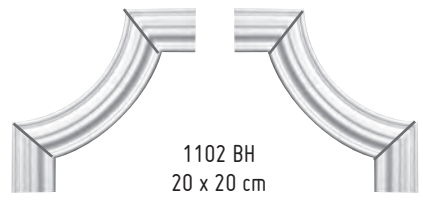

1107 (en 1,50 ml)

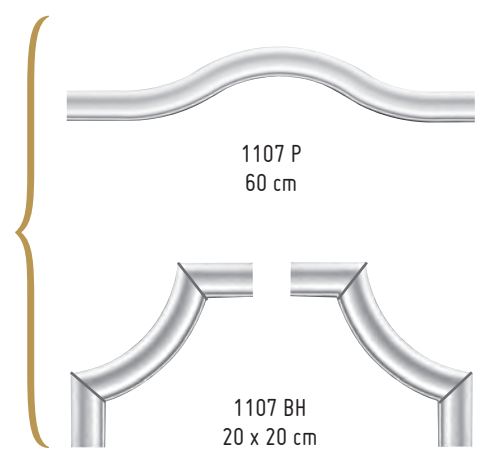

1101 (en 1,50 ml)

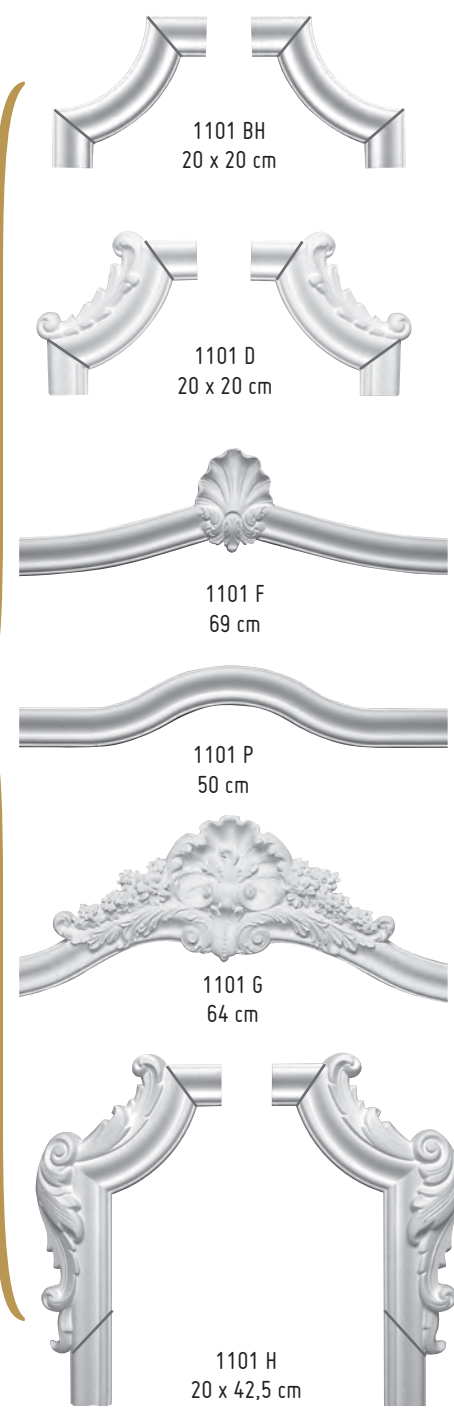

1207 (en 1,50 ml)

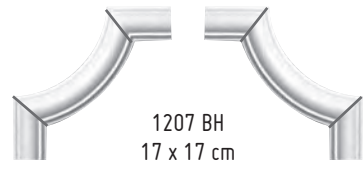

1208 (en 1,50 ml)

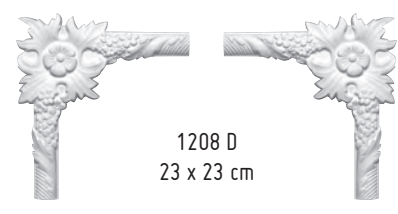

1202 (en 1,50 ml)

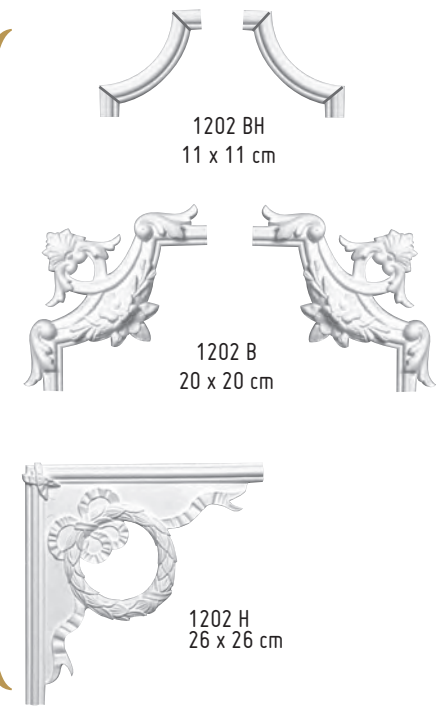

Mise en oeuvre
 Pour la pose des angles, coupez les amorces comme indiqué ci-dessus par le trait gris.

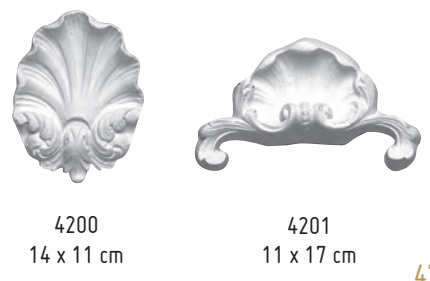
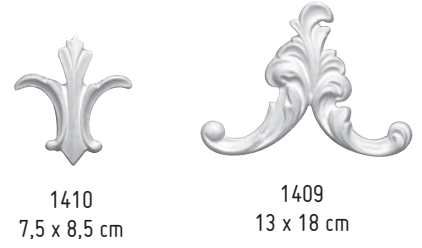
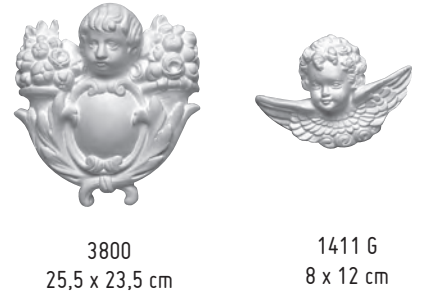
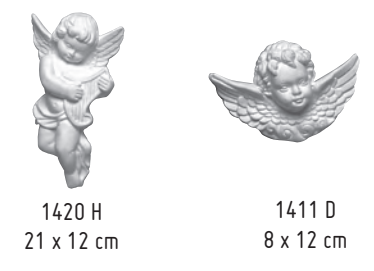
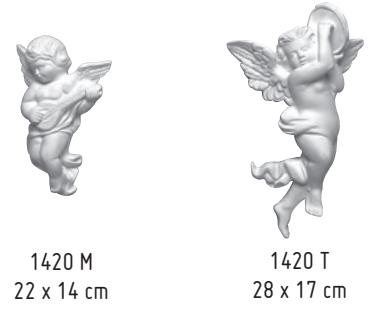



CAISSONS 50.NIAG
60 X 60 CM
PAGE 65
© The White House, Cannes

GUIDE LÉGENDE



Rosace à coller ou pouvant être encastrée

LES ROSACES & LES CAISSONS

ROSACE M301
PAGE 54
© Charles Cameron



LES ROSETTES



1401 - ø 5,5 cm



1403 - ø 6 cm



1400 - ø 6 cm



M049 - ø 6 cm



1402 - ø 6,5 cm



1415 - ø 7 cm



1416 - ø 8 cm



1413 - 9 x 7 cm



1404 - ø 8,5 cm



1405 - ø 9 cm



M050 - ø 10 cm



1407 - 10,5 x 10,5 cm



1412 - ø 11,5 cm



1406 - ø 12 cm



1408 - ø 14 cm



M038 - ø 16 cm



1414 - ø 19 cm



M043 - ø 29 cm



M047 - ø 32 cm



M041 - ø 32 cm



M058 - ø 32,5 cm



M042 - ø 33 cm



M102 - ø 36 cm



M100 - ø 39 cm



M101 - ø 39 cm



M044 - ø 40 cm



M040 - ø 40 cm



M211 - ø 43,5 cm

ROSACES



M205 - ø 45 cm



M202 - ø 49 cm



M059 - ø 44 cm



M057 - ø 49 cm



M204 - ø 49 cm



M073 - ø 50 cm



M051 - ø 49,5 cm



M072 - ø 51 cm



M061 - ø 52 cm



M056 - ø 51,5 cm



M201 - ø 52 cm



M053 - ø 52 cm



M055 - 65 x 32 cm



M045 - 41 x 30 cm



M213 - ø 46 cm



M206 - ø 57 cm



M046 - 42 x 32 cm



M207 - 53 x 44 cm



M297 - ø 58 cm



M300 - ø 60 cm



M301 - ø 60 cm



M299 - ø 60 cm



M254 - ø 60 cm



M070 - ø 64 cm



M302 - ø 70 cm



M303 - ø 70 cm



M304 - ø 70 cm



M052 - ø 72,5 cm



 M401 - ø 90 cm



 M402 - ø 90 cm



 M403 - ø 87 cm





 M405 - ø 96 cm

ROSACE M405
© Charles Cameron

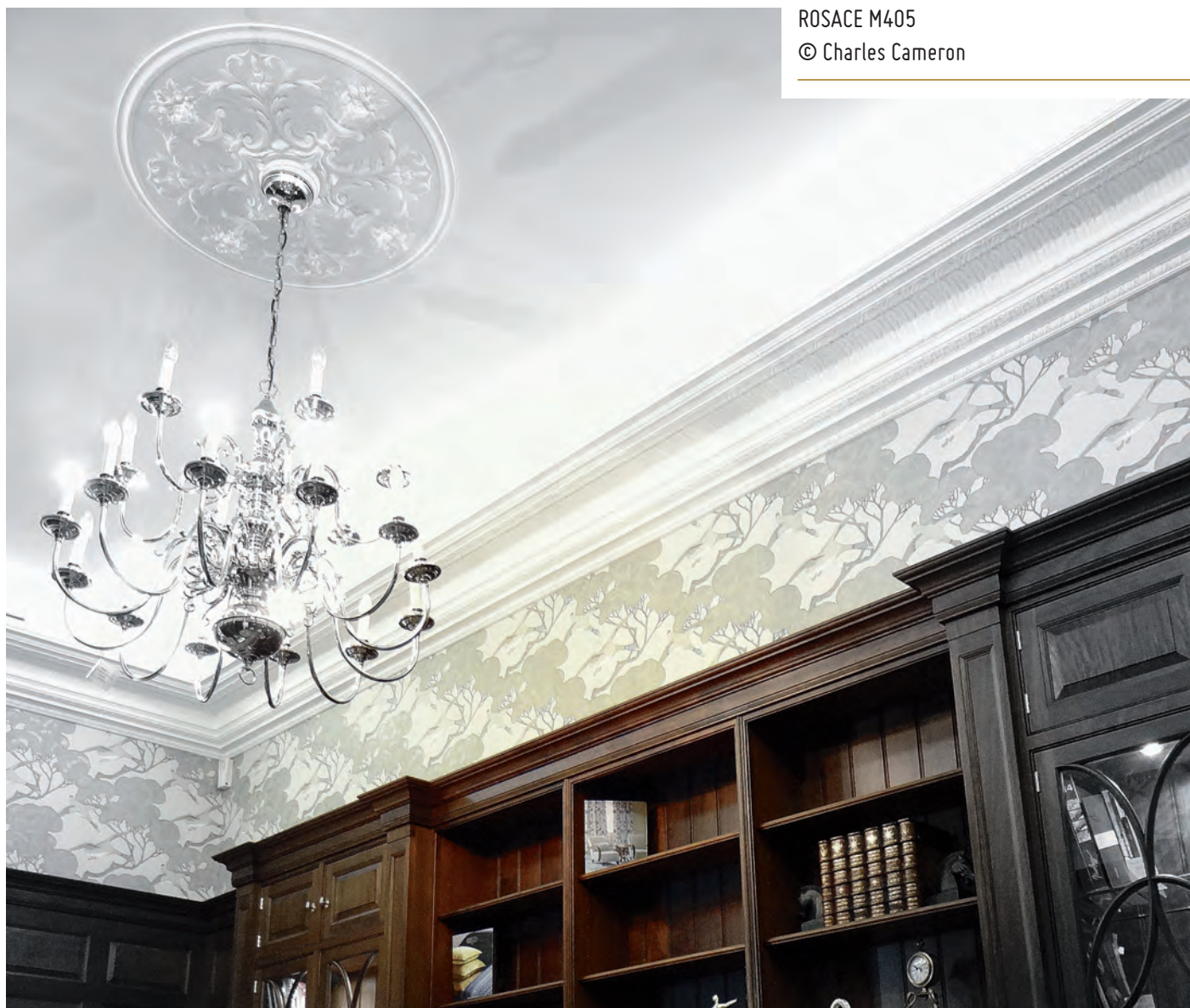



ROSACE M407



M407 - 124 x 80 cm





M209 - 64 x 48 cm



M071 - 88 x 74 cm



M210 - 60 x 41 cm



M068 - 55 x 39 cm



M039 - 59 x 38 cm



M069 - 72 x 42 cm



M203 - ø 50 cm



M048 - 57 x 32 cm



M208 - 51 x 40 cm



 M404 - ø 104 cm



 M067 - 91,5 x 46 cm



 M390 - 105 x 83 cm



 M255 - ø 84 cm



M296 - ø 63 cm



M406 - 84 x 44 cm



 M400 - 100 x 70 cm



M054 - 76 x 61 cm



M306 - ø 80 cm



M298 - 59 x 47 cm



M066 - ø 50 cm



M212 - ø 49 cm

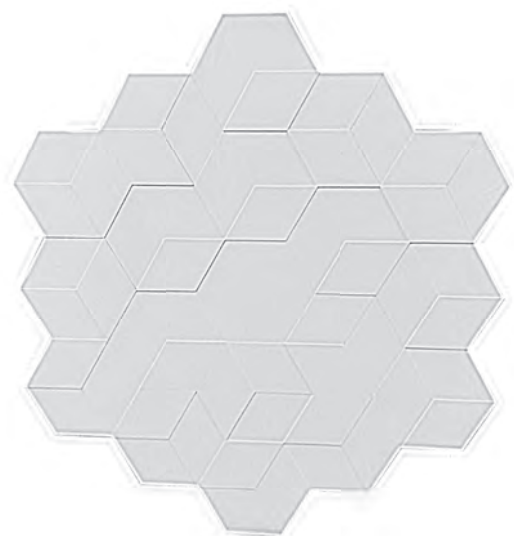

M502 - 88,4 x 95,7 cm
Livrée avec 3 hexagones en staff



M253 - ø 46 cm



M252 - ø 56 cm



M060 - ø 62 cm



M251 - ø 66 cm



M250 - ø 77 cm



ROSACE M501 - 80 x 80 cm
© Hôtel Victor Hugo, Pontorson.

CARACTÉRISTIQUES
TECHNIQUES

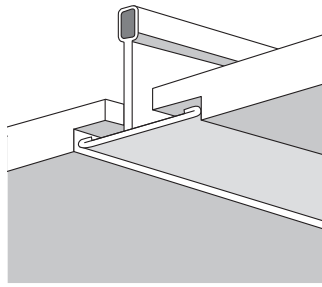

- > **Composition :** plâtre armé de fibre de verre.
Matériau naturel ne contenant aucune substance toxique.
- > **Poids :** Selon les modèles,
compris entre 9 et 22 Kg/m².
- > **Réaction au feu :** classement M0 et A1
Non Combustible.
- > **Type de montage :** Sur ossature semi-cachée
selon schéma ci-contre ou
scellement traditionnel.



CAISSON 50.NIAG
60 x 60 cm
© The White House, Cannes

50.NIAG
60 x 60 cm
Niagara - H 10 cm - 7,7 kg.



50.SIER
60 x 60 cm
Sierra - H 9 cm - 7,9 kg.



50.050
60 x 60 cm
H 2 cm - 7 kg.



50.ATLA
60 x 60 cm
Atlas - H 3 cm - 3kg.



STAFF DÉCOR peut également réaliser à la demande, tout modèle spécifique de caisson de plafond.



FRONTON B700
PAGE 69

LA COLLECTION ORIENTALE

MOULURE 1250G
en 2 ml
PAGE 68

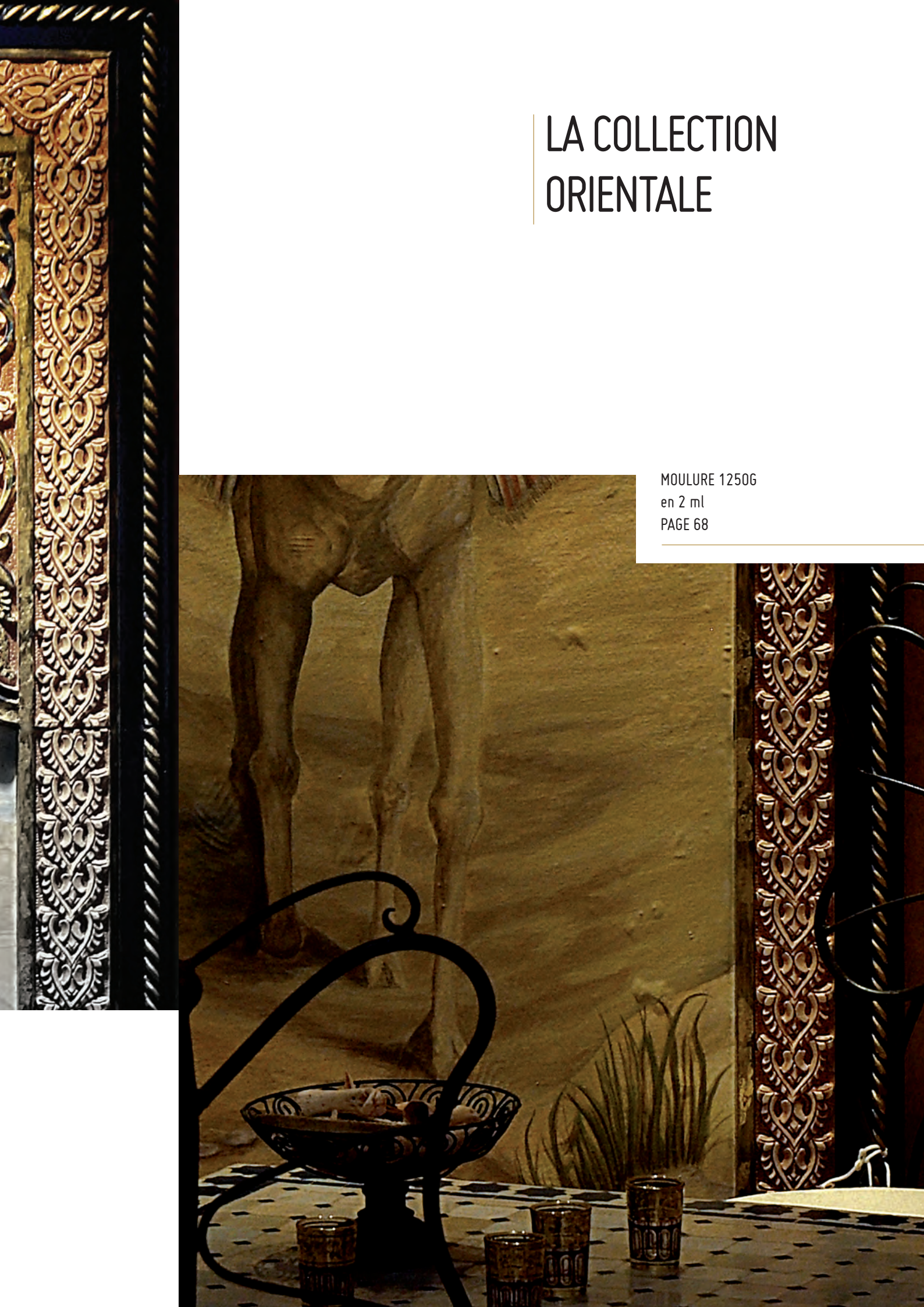

MOULURES ET FRISES



1250G ou D
L 200 cm x H 15 cm



1253
L 210 cm x H 39 cm



1254
L 215 cm x H 26 cm



1252
L 187 cm x H 63 cm



1251
L 209 cm x H 35 cm



1271
22 x 19 cm

Les écoinçons sont livrés séparément. Ils sont destinés à faciliter les raccords et les arrêts de la frise.



1275
L 150 cm x H 45 cm

ABAT-JOUR



Abat-jour 201

ROSACES



M421
ø 83 cm



M422
ø 100 cm



M420
153 x 81 cm

FRONTONS & CHAPITEAUX



B700
Fronton 100 cm x 70 cm
Flèche : 37 cm - corde : 71 cm



B702
Fronton 166,5 cm x 68 cm
Flèche : 52 cm - corde : 167 cm

1/2 chapiteau
40.61
22 cm x 11 cm x H 11 cm



B701
Fronton 125 cm x 83 cm
Flèche : 57 cm - corde : 95 cm

Demi-fût torsadé
32.51
ø 15 cm, H 200 cm



1/2 collerette basse
45.51C



B703
79 cm x 20,5 cm

CÔTÉ DE PASSAGE 2024
PAGE 140



CIMAISE 1101C
PAGE 103



FRONTON 3900

PAGE 106

TÊTE DE PILASTRE 0802

PAGE 116

PILASTRE 0800

PAGE 116

PAREMENTS

PAGE 74

LES MURS



© The White House, Cannes



	LES PAREMENTS	74
	PIERRES ET BRIQUETTES	76
	COLLECTION BOIS	80
	COLLECTION CONTEMPORAINE	81
	PANNEAUX DE GRANDES DIMENSIONS	92
	L'HABILLAGE MURAL PAR LAMBRISSAGE	96
	PLATE BANDE, ANGLES DE PLATE BANDE & CIMAISES	98
	LAMBRIS DÉCAISSÉS	99
	TÊTES POUR PILASTRES	100
	INTERCALAIRES, STYLOBATES	
	ÉLÉMENTS DE CIMAISES, PLINTHES	101
	AUTRES SOLUTIONS POUR VOS SOUBASSEMENTS	102
	LES HABILLAGES DE PORTE	104
	LE CONTEMPORAIN	104
	LES CLASSIQUES	105
	LES COUVRE-JOINTS	106
	LES TALONS DE PORTE	106
	LES FRONTONS	106
	FRONTONS RECTANGULAIRES	106
	FRONTONS ORNEMENTÉS	107
	LES COLONNES & PILASTRES	108
	LES COLONNES	108
	LES PILASTRES	113
	LES BALUSTRES	117



PAREMENT FACET
CL31
PAGE 86
© Interlam

LES PANNEAUX 3D & PAREMENTS

PAREMENT RR COLLECTION
7063
PAGE 91
© Barbiéri



PIERRES & BRIQUETTES



7060
Bruges
87 x 60 cm
Épaisseur : 1,5 cm
Poids unitaire : 6,5 kg
Conditionnement à l'unité
avec briquettes de liaison



7061
New-York
93 x 54 cm
Épaisseur : 1,5 cm
Poids unitaire : 6,5 kg
Conditionnement à l'unité



SD7054
Brooklyn
48,6 x 12,1 x 1,3 cm / unité
Conditionnement : carton de 20 unités
Vendu en carton de 0,92 m²
Poids au m² : 13 kg



SD7047
Soho
9,8 x 50,8 x 1,5 cm / unité
Conditionnement : carton de 25 unités
Vendu en carton de 1 m²
Poids au m² : 13,5 kg



SD7056
Queens
99,5 x 19 x 1,4 cm / unité
Conditionnement : carton de 5 unités et
10 briquettes de liaison
Vendu en carton de 0,94 m²
Poids au m² : 13 kg



SD7042
Harlem
100x20x1,5 cm / unité
Conditionnement : carton de 5 unités
Vendu en carton de 1 m²
Poids au m² : 13 kg



7038
Tétris
100 x 84 cm
Épaisseur : 2 cm
Poids unitaire : 10 kg
Conditionnement à l'unité
Surface : 0,71 m²



7040
Pierre joint sec GM
100 x 72,5 cm
Épaisseur : 2 cm
Poids unitaire : 8,5 kg
Conditionnement à l'unité
Surface : 0,56 m²



7041
Pierre joint sec PM
95 x 72cm
Épaisseur : 2,4 cm
Poids unitaire : 12,5 kg
Conditionnement à l'unité
Surface utile : 0,61 m²



7048
Pierre de parement blanche
7049
Pierre de parement teintée

La finition blanche donne l'effet calcaire de la pierre du Gard. La finition teintée dans la masse rappelle la pierre de Tuffeau.

Aucun raccord apparent, les joints sont pré-moulés sur deux côtés du parement (joint vertical et horizontal).

Livrées par carton de 1 m² comprenant

- 1 élément 70 x 35 cm / épaisseur: 1,4 cm
- 1 élément 60 x 35 cm / épaisseur: 1,4 cm
- 1 élément 50 x 35 cm / épaisseur: 1,4 cm
- 2 éléments 40 x 35 cm / épaisseur: 1,4 cm
- 3 éléments 12 x 35 cm / épaisseur: 1,4 cm

Poids du carton : 14 kg

Pour les finitions :

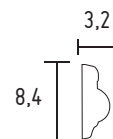

7051 (en 1,50 ml) Moulure pierre teintée
7053 (en 1,50 ml) Moulure pierre blanche

Talon TALP
épaisseur 4 cm

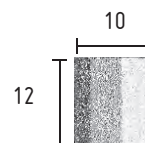

PAREMENTS 7041
PAGE 76

COMMENT UTILISER NOS PAREMENTS ?

POUR CLOISONNER OU SÉPARER...



PAREMENT 7073
PAGE 82

POUR VOS FINITIONS...
DESSINEZ UN BAR OU UN COMPTOIR...

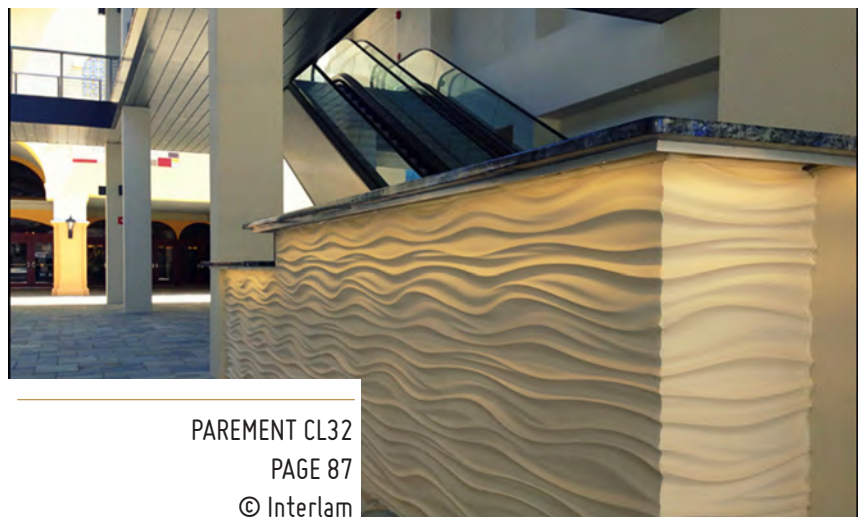

PAREMENT CL32
PAGE 87
© Interlam

POUR UNE TÊTE DE LIT..

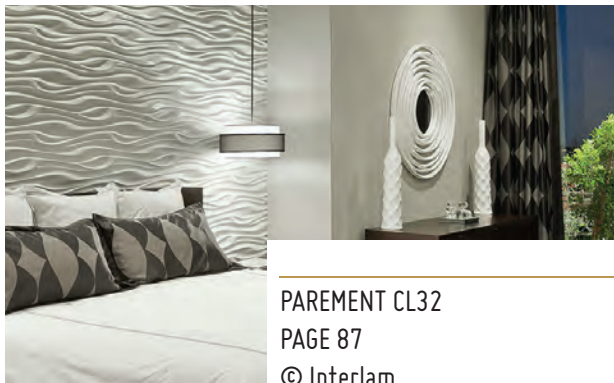

PAREMENT CL32
PAGE 87
© Interlam



PAREMENT SD7500
PAGE 81

POUR REMPLACER UN TABLEAU...

PAREMENT SD7055
PAGE 84



CONSEIL DE POSE :

Pose par collage avec enduit cellulosique de type "Staff Décor"

Les finitions de nos produits sont en plâtre brut et prêts à peindre.

POUR HABILLER VOS CHEMINÉES...

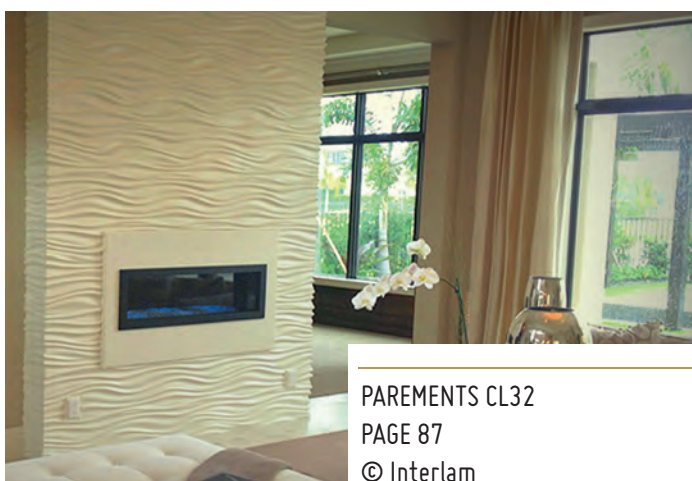

PAREMENTS CL32
PAGE 87
© Interlam

DIY ?

Scannez &
suivez notre tutoriel !



LES BOIS



PAREMENT SD7043



SD7043
Forest Hill (Brique)te)
100 x 20,8 x 1,8 cm / unité
Conditionnement : carton de 5 unités
Vendu en carton de 0,94 m²
Poids au m² : 15 kg

SD7044
Forest Hill (Lame)
100 x 10 x 1,3 cm / unité
Conditionnement : carton de 10 unités
Vendu en carton de 1m²
Poids au m² : 13,6 kg



SD7052
Greenwich
99 x 19,2 x 1,4 cm / unité
Conditionnement : carton de 5 unités
et 10 briquettes de liaison
Vendu en carton de 0,94 m²
Poids au m² : 13 kg

SD7057
120 x 25 x 1,4 cm / unité
Conditionnement : carton de 2 unités
Vendu en carton de 0,6 m²
Poids au m² : 15 kg

COLLECTION CONTEMPORAINE

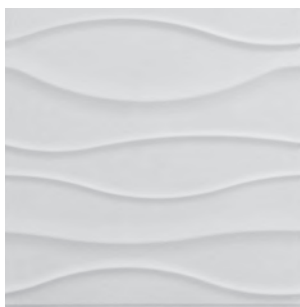

SD7500
Key West



SD7501
Daytona



SD7502
Square Garden

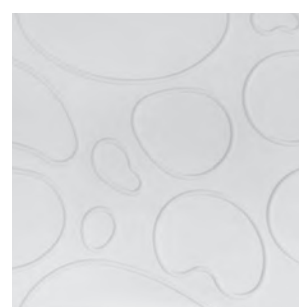

SD7503
Everglades

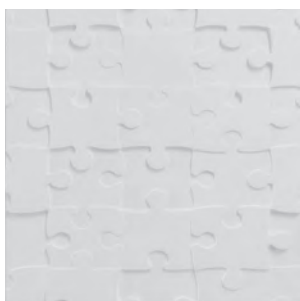

SD7504
Orlando

GAMME « JOINTS CREUX »

Caractéristiques techniques communes à l'ensemble de la gamme :

60 x 60 cm / unité

Conditionnement : carton de 2 éléments

Poids du carton : 13 kg sauf SD7500 à 12 kg

Vendu en carton de 0,72 m²

Pose par collage avec enduit cellulosique "Staff Décor"

Finition : plâtre brut

Le produit est prêt à peindre.

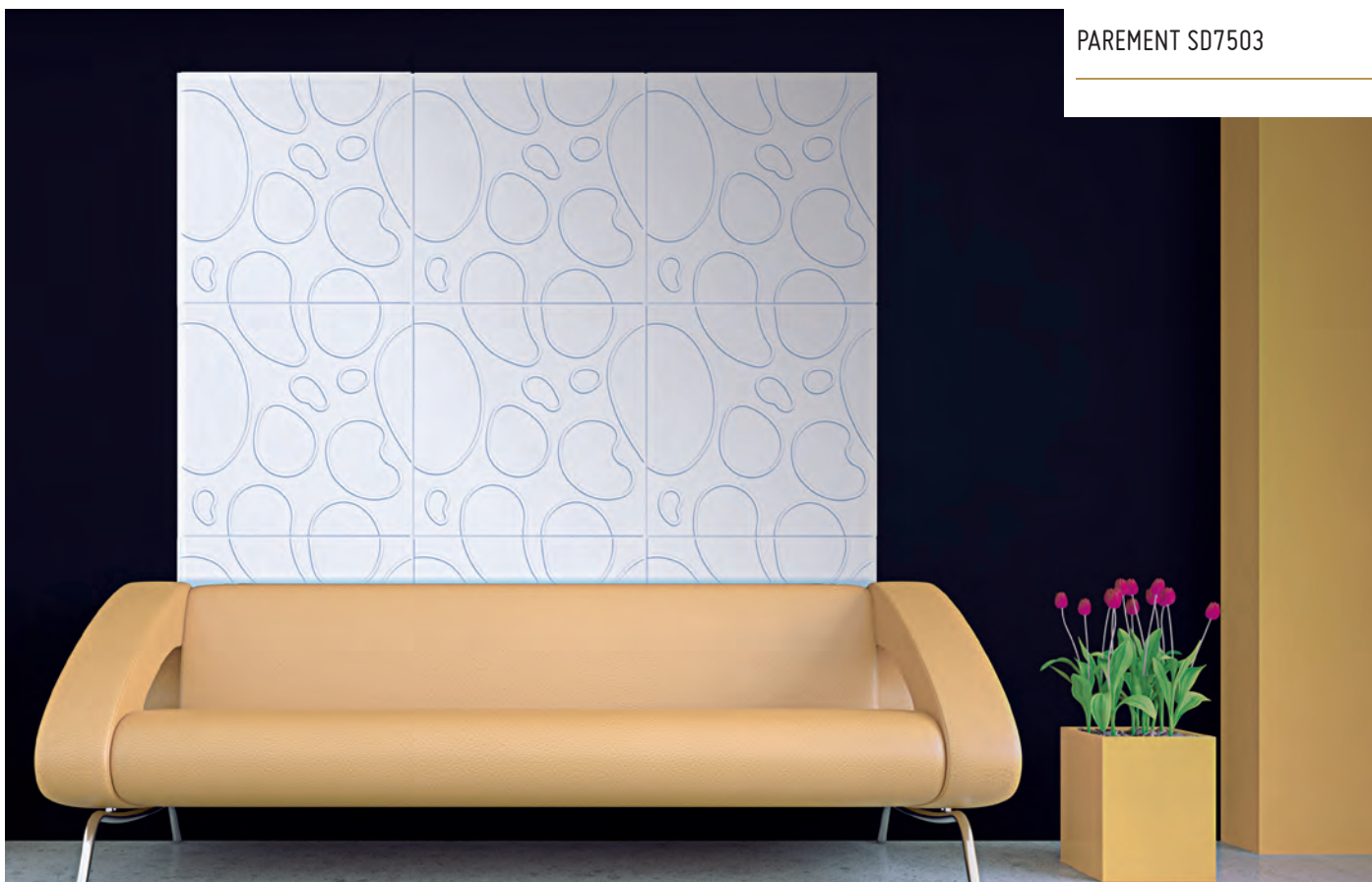

PAREMENT SD7503

PAREMENTS



7070
Panneau Bulles
120 x 60 cm
Epaisseur : 1,25 cm min / 2,3 cm max
Poids unitaire : 9,5 kg
Conditionnement à l'unité
© Design by Lionel Brehelin

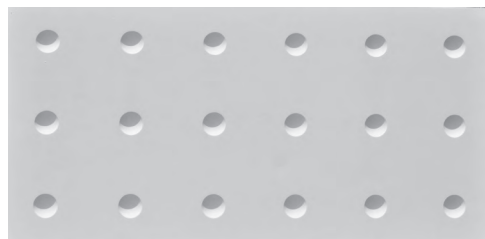

7071
Panneau Golf
120 x 60 cm
Epaisseur : 1,25 cm
Poids unitaire : 9,1 kg
Conditionnement à l'unité
© Design by Lionel Brehelin

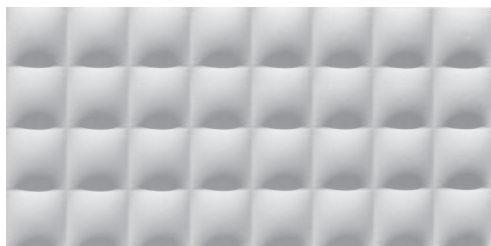

7072
Panneau Capitons
120 x 60 cm
Epaisseur : 1,25 cm min / 2,3 cm max
Poids unitaire : 13,5 kg
Conditionnement à l'unité
© Design by Lionel Brehelin



7073
Panneau Macarons
120 x 60 cm
Epaisseur : 1,25 cm
Poids unitaire : 9,2 kg
Conditionnement à l'unité
© Design by Lionel Brehelin



7074
Panneau Virgules
120 x 60 cm
Epaisseur : 1,25 cm
Poids unitaire : 9,3 kg
Conditionnement à l'unité
© Design by Lionel Brehelin



7075
Panneau Caro
120 x 60 cm
Epaisseur : 1,25 cm
Poids unitaire : 9,2 kg
Conditionnement à l'unité
© Design by Lionel Brehelin



PAREMENT 7072

PAGE 82

© Design by Lionel Brehelin

PAREMENTS



50.LET1
Dalle palmier droite
40 x 40 cm
Epaisseur : 1,5 cm
Conditionnement à l'unité
Poids unitaire : 3kg
© Design by Patrick le Tuault



50.LET2
Dalle palmier gauche
40 x 40 cm
Epaisseur : 1,5 cm
Conditionnement à l'unité
Poids unitaire : 3kg
© Design by Patrick le Tuault



50.LET3
Dalle palmier
40 x 40 cm
Epaisseur : 1,5 cm
Conditionnement à l'unité
Poids unitaire : 3kg
© Design by Patrick le Tuault



SD7045
Luna Park (Lame)
100 x 20 x 1,3 cm / unité
Conditionnement : carton de 5 unités
Vendu en carton de 1 m²
Poids au m² : 13 kg



SD7055
Broadway
40 x 40 x 2 cm / unité
Conditionnement : carton de 6 unités
Vendu en carton de 0,96 m²
Poids au m² : 12 kg

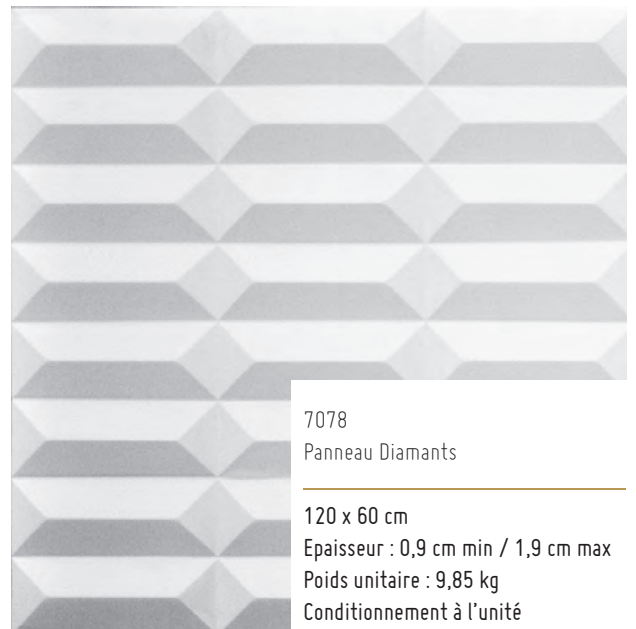

7078
Panneau Diamants

120 x 60 cm
Epaisseur : 0,9 cm min / 1,9 cm max
Poids unitaire : 9,85 kg
Conditionnement à l'unité

Besoin de conseils pour le
choix de vos parements ?
Découvrez notre article et
inspirez-vous !



SD7046
V^{ème} avenue
40 x 40 x 1,5 cm / unité
Conditionnement : carton de 6 unités
Vendu en carton de 0,96 m²
Poids au m² : 13 kg



PAREMENTS SD7046

Nos best-of

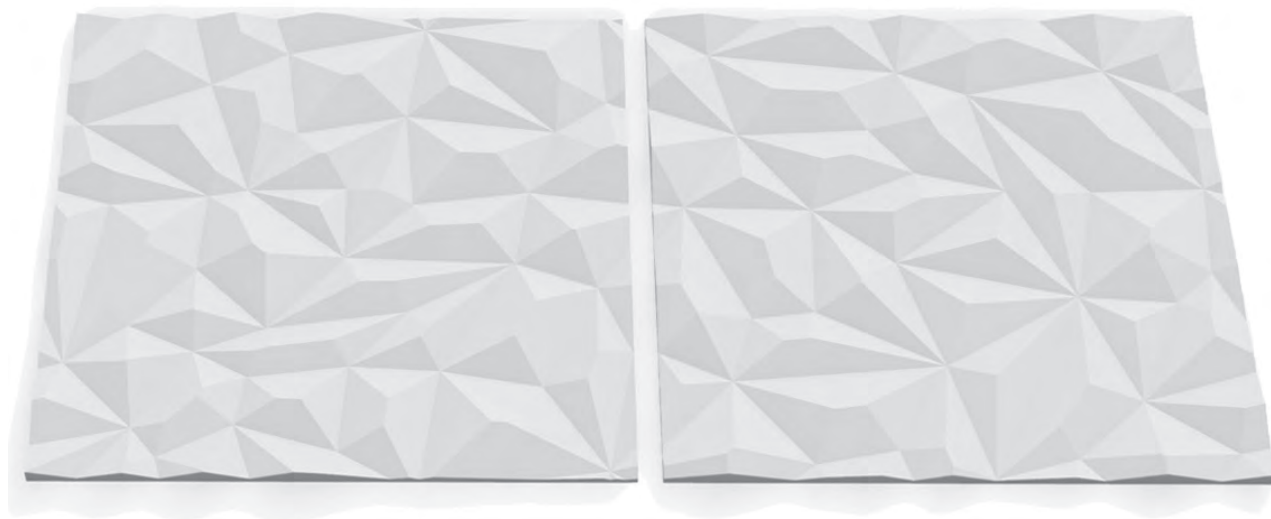

CL31A et B
 Facet
 122 x 122 cm
 Conditionnement à l'unité
 Epaisseur : 2 cm
 Surface : 1,49 m² /plaque
 Poids unitaire : 23 kg
 © Design by Interlam

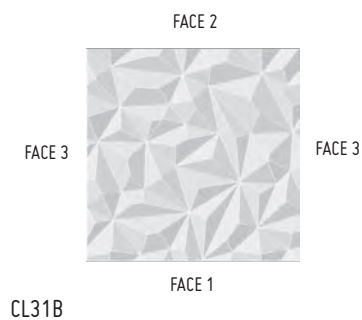
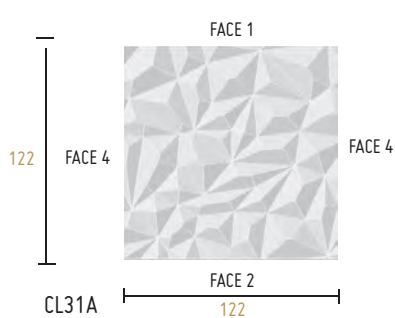



PAREMENT CL32
© Interlam



CL32
Vague relief
122 x 122 cm
Conditionnement à l'unité
Epaisseur : 1,6 à 3,5 cm
Surface : 1,49 m² / plaque
Poids unitaire : 16 kg
© Design by Interlam

CL33
Cloud
122 x 122 cm
Conditionnement à l'unité
Epaisseur : 1,2 à 3 cm
Surface : 1,49 m² / plaque
Poids unitaire : 16 kg
© Design by Interlam

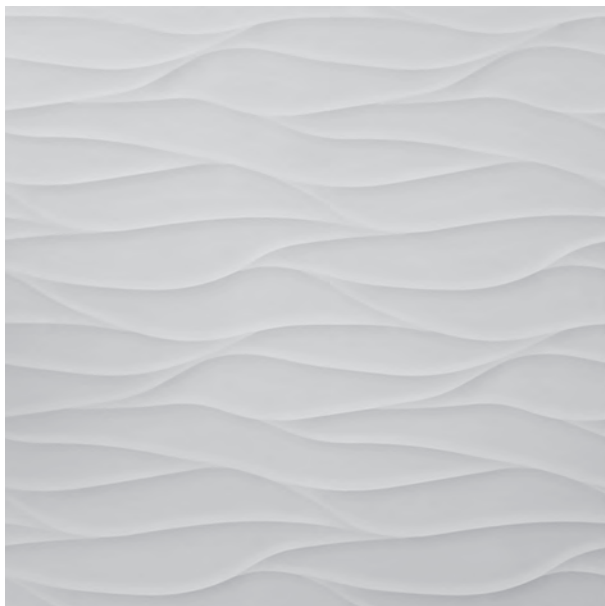

CL34
Bio
122 x 122 cm
Conditionnement à l'unité
Épaisseur : 3 à 3,7 cm
Surface : 1,49 m² / plaque
Poids unitaire : 18 kg
© Design by Interlam



CL35
Crystal
122 x 122 cm
Conditionnement à l'unité
Épaisseur : 3 à 3,7 cm
Surface : 1,49 m² / plaque
Poids unitaire : 18 kg
© Design by Interlam



CL36
Prisme
122 x 122 cm
Conditionnement à l'unité
Épaisseur : 3,2 cm
Surface : 1,49 m² / plaque
Poids unitaire : 18 kg



PAREMENTS 7035

Labrys

Plaque de 30,4 x 48,15 cm
Conditionnement à l'unité
Épaisseur : 3,6 cm
Surface : 0,09 m²
Poid unitaire : 3,2 kg/plaque
© Design by Interlam



SOLUTION D'HABILLAGES CLÉ EN MAIN

*Une plaque
de parement*

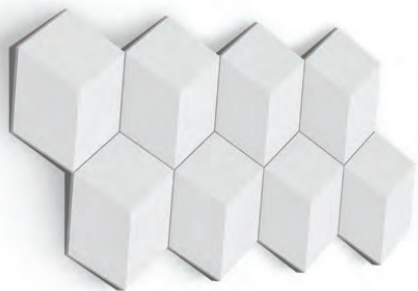

7036
Multiface
Plaque de 8 carreaux de 106,6 x 47,9 cm
Conditionnement à l'unité
Épaisseur : 3,7 cm
Surface : 0,4 m²
Poids unitaire : 9,6 kg
© Design by Interlam

*des pièces
individuelles*

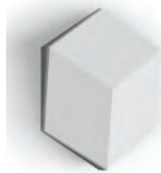

7036U
1 carreau de 23,6 x 27,4 cm
Conditionnement à l'unité
Épaisseur : 3,7 cm
Surface : 0,05 m²
Poids unitaire : 1,2 kg
© Design by Interlam

*Une plinthe
mise en forme*



7036PLIN
Plinthe de 1,42 ml
Conditionnement à l'unité
Hauteur : 16,9 cm
Épaisseur : 2,2 cm
Surface : 0,19 m²
Poids unitaire : 2,8 kg
© Design by Interlam

PAREMENT 7036
Multiface
© Interlam



LES PAREMENTS SIGNÉS GIOVANI BARBIERRI



7039A

44 x 44 cm – épaisseur : 3,5 cm environ

Conditionnement à l'unité

Surface : 0,12 m²

Poids unitaire : 2,7 kg soit 22,5 kg/m² environ

© Barbierrri

7039B

44 x 44 cm – épaisseur : 3,5 cm environ

Conditionnement à l'unité

Surface : 0,12 m²

Poids unitaire : 2,7 kg soit 22,5 kg/m² environ

© Barbierrri

Composez en fonction de vos envies !

PAREMENTS 7039A & 7039B

FLOWER

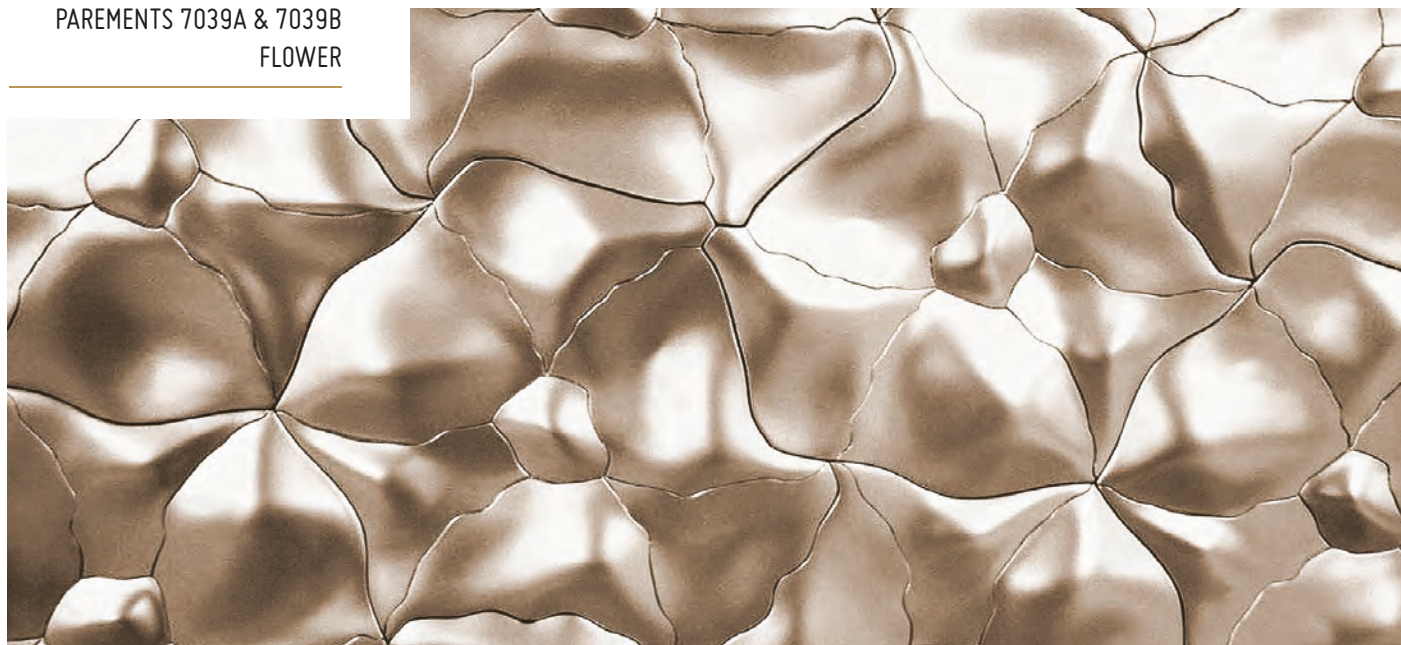



PAREMENTS 7062
MOSAÏC

66 x 16 cm – épaisseur : 1,7 cm
Surface : 0,10 m²
Poids unitaire : 1,45 kg
Conditionnement : vendu en carton de 1 m²
© Barbiéri



Détail du raccord

Scannez pour découvrir nos solutions de calepinage !



À partir de 4 matrices différentes, composez vous-même un habillage mural à votre image !



PAREMENTS 7063
RR COLLECTION

40,5 x 29,4 cm
Épaisseur variable en fonction du motif. Entre 1,3 cm et 2,5 cm.
Poids unitaire : 1,45 kg
Conditionnement :
vendu en carton de 1 m²
7063-1 : Motifs plats
7063-2 : Motifs plats et incurvés
7063-3 : Motifs incurvés et bombés
7063-4 : Motifs bombés
© Barbiéri

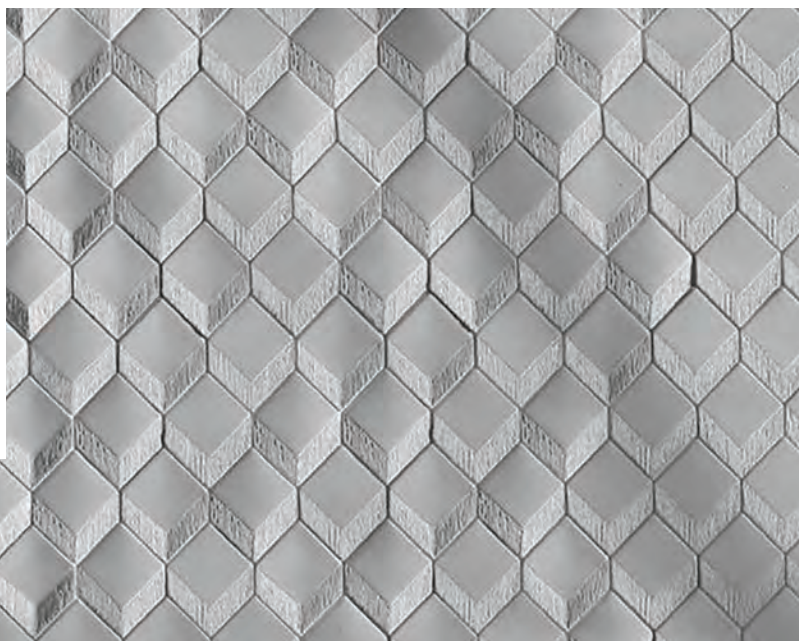

LES PANNEAUX GRANDES DIMENSIONS

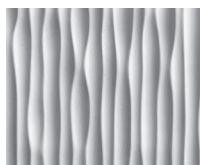
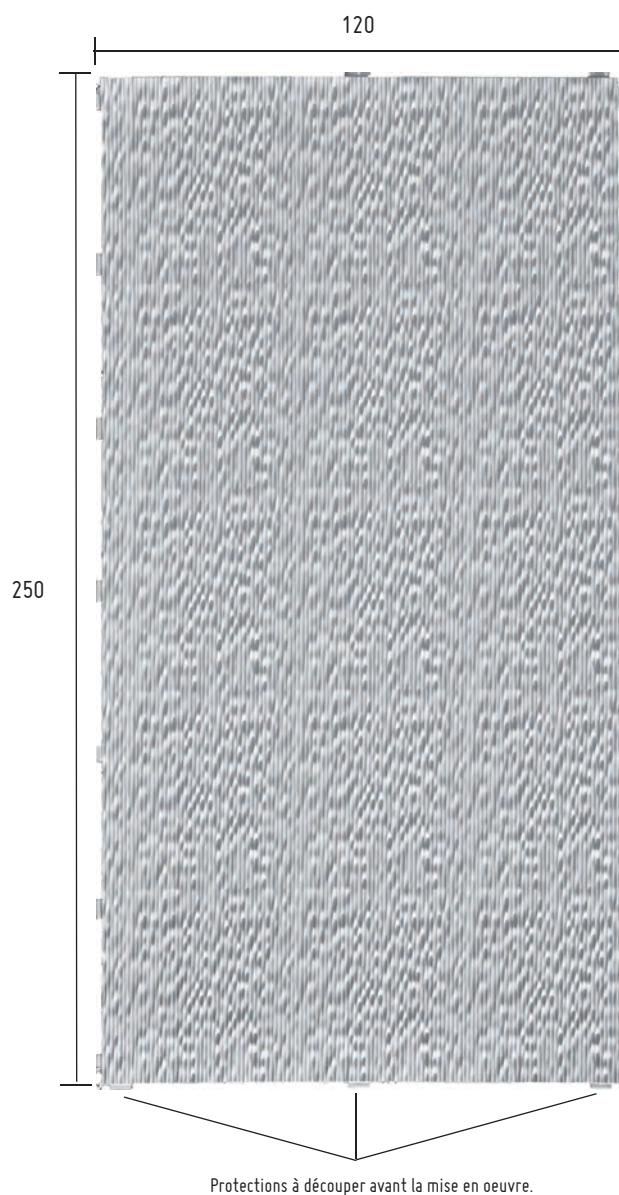

CL10
Motif vertical
Dimensions : 120 x 250 cm
Conditionnement à l'unité
Surface : 3 m²
Poids unitaire : 18 kg.

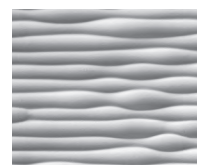

CL11
Motif horizontal
Dimensions : 120 x 250 cm
Conditionnement à l'unité
Surface : 3 m²
Poids unitaire : 18 kg.



Mise en oeuvre :

Collage des panneaux à l'enduit STAFF DECOR (seau de 10 kg, référence 0010) sur les supports courants (plâtre, béton, plaque de plâtre ...).

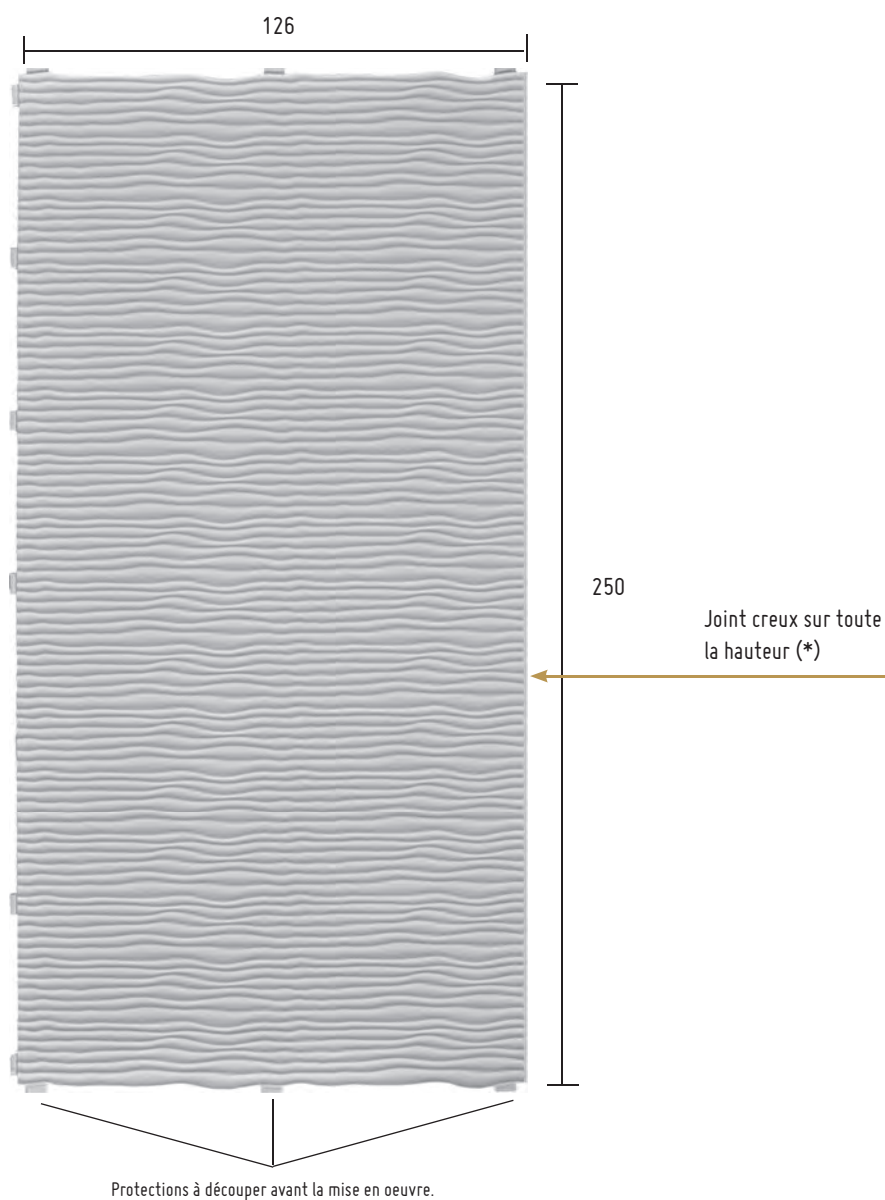

CL1374
 Dimensions : 126 x 250 cm
 Conditionnement à l'unité
 Surface : 3,15 m²
 Poids unitaire : 18 kg.



Zoom
 sur le joint creux.

*Le panneau référence CL1374 présente un joint creux d'une largeur de 1 cm sur un côté. Pour un résultat sans raccord apparent (bord à bord), ce joint doit être découpé.

Pensez à composer :
 Découvrez la moulure 1374 afin d'accompagner votre parement !
 (page 42 de notre catalogue)



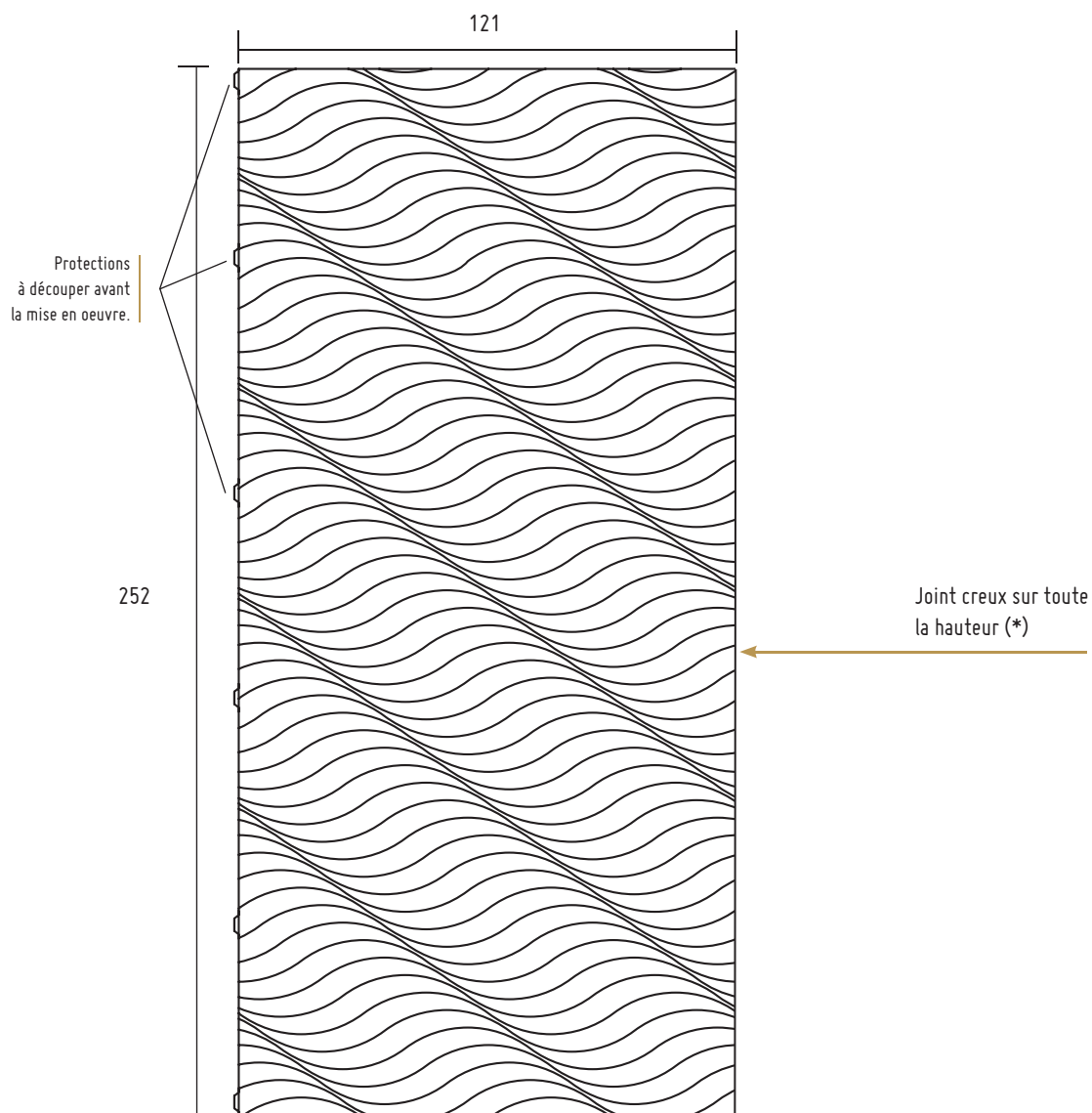

CL12 Ondes
Dimensions : 121 x 252 cm
Conditionnement à l'unité
Surface : 3,05 m²
Poids unitaire : 18 kg.



*Le panneau référence CL12 présente un joint creux d'une largeur de 1 cm sur un côté. Pour un résultat sans raccord apparent (bord à bord), ce joint doit être découpé.



PAREMENT CL1374
Page 93



PAREMENT CL12
ONDES

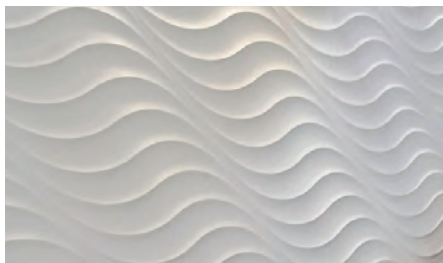



SOUBASSEMENTS MOULURÉS
© Château Mader

L'HABILLAGE MURAL PAR LAMBRISSAGE



SOUBASSEMENTS MOULURÉS
© Château Mader





COMPRENDRE NOS PRODUITS DE SOUBASSEMENTS & ENCADREMENTS MURAUX AFIN DE CHOISIR CELUI QU'IL VOUS FAUT

- 1 - Lambris décaissé
- 2 - Cimaïse
- 3 - Plinthe
- 4 - Intercalaire
- 5 - Plate bande simple côté
- 6 - Plate bande double côté
- 7 - Angle de plate bande
- 8 - Tête de pilastre
- 9 - Pilastre
- 10 - Cimaïse de stylobate
- 11 - Stylobate

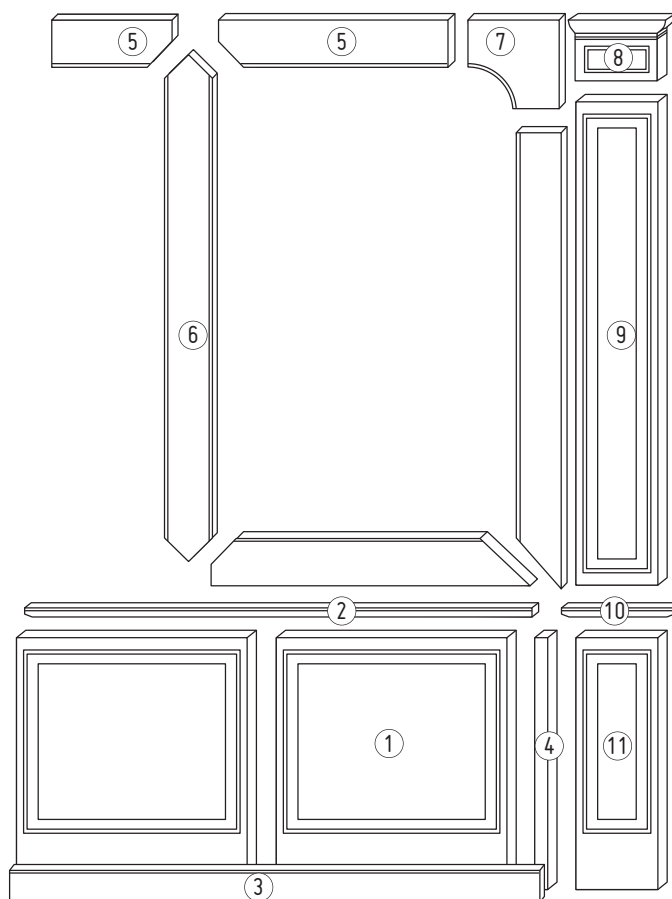

PLATES BANDES, ANGLES DE PLATE BANDE & CIMAISES

Épaisseur : 1,5 cm

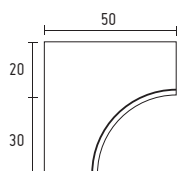

9312

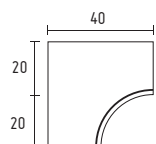

9311

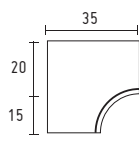

9310

Épaisseur : 1,5 cm

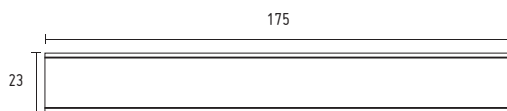

9303

Plate bande double côté

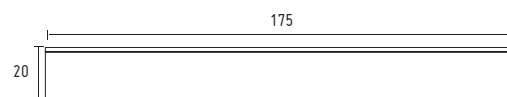

9301

Plate bande simple côté

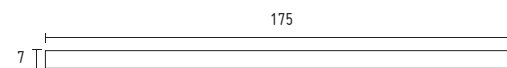

9302

Plate bande simple étroite

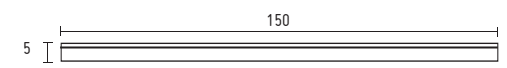

9315C

CIMAISE



LAMBRIS DÉCAISSÉS

SOUBASSEMENT 9222



3 Hauteurs disponibles : 55, 75 et 85 cm
 (Hauteur du lambris sans cimaise)
 Épaisseur : 2,3 cm

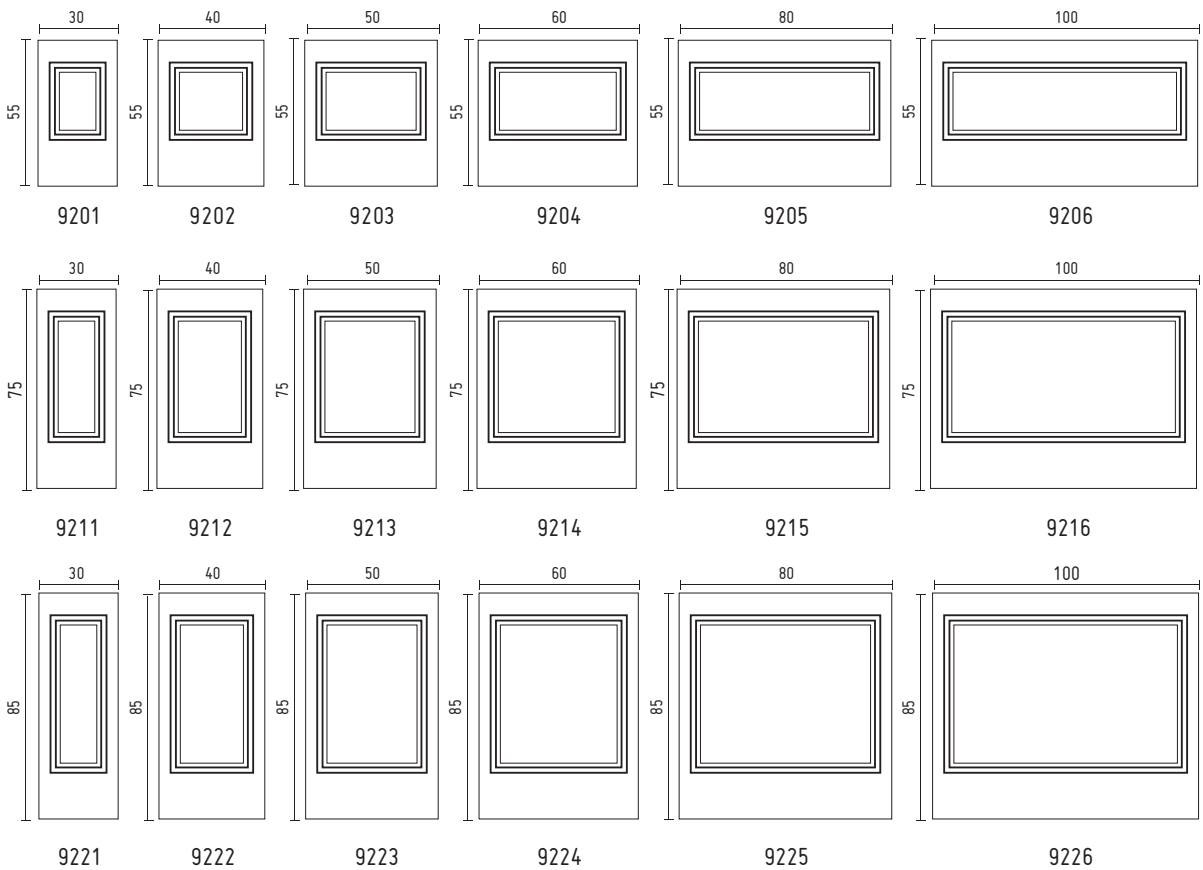

TÊTES POUR PILASTRES

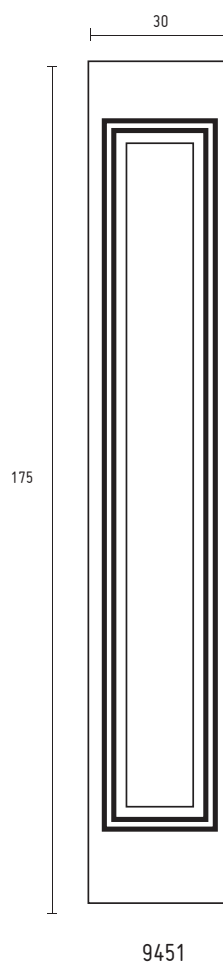
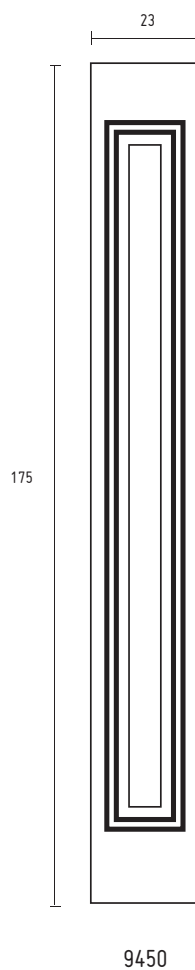
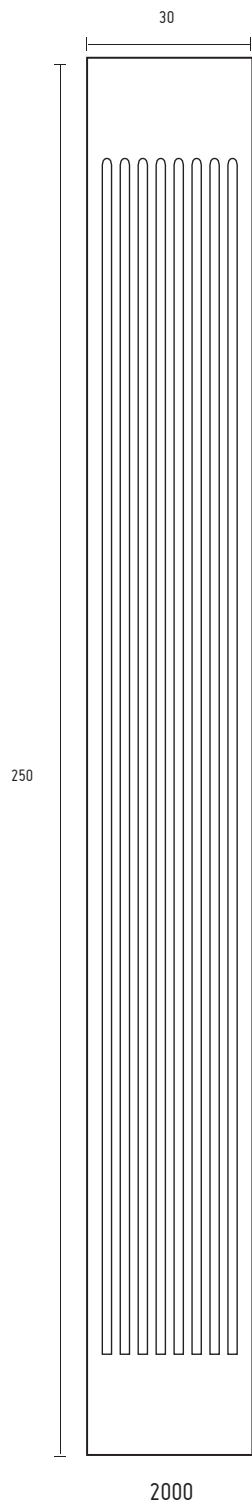
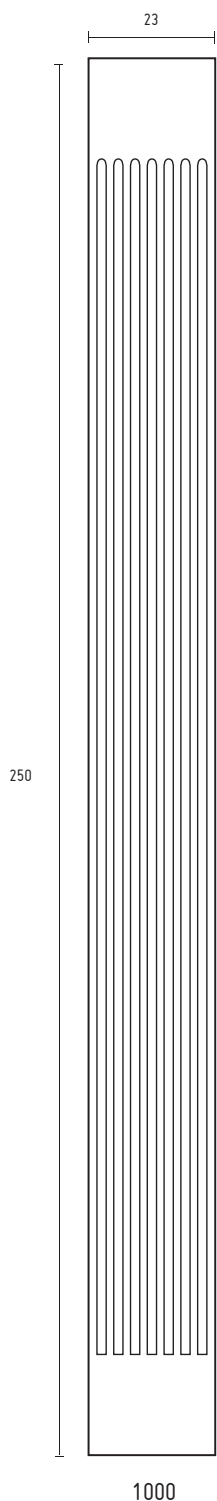
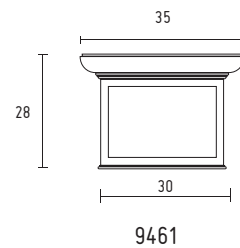
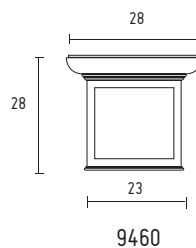
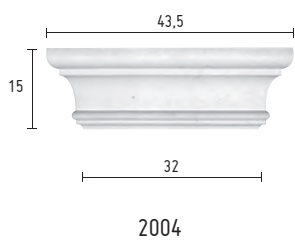
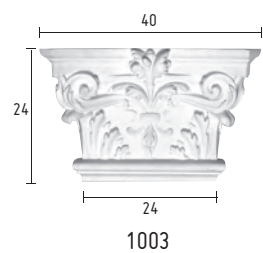

Retrouvez toutes nos têtes de pilastres, pilastres et socles à partir de la page 113 !

INTERCALAIRES, STYLOBATES ÉLÉMENTS DE CIMAISES, PLINTHES

Épaisseur : 7 cm
Éléments de cimaise

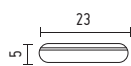

9315.23

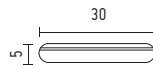

9315.30

Épaisseur : 2 cm
Intercalaire

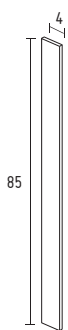

9280

Épaisseur : 4,5 cm
Stylobates

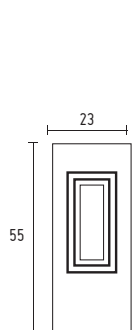

9401

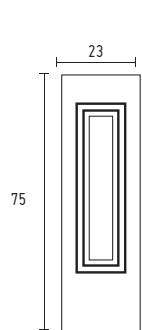

9402

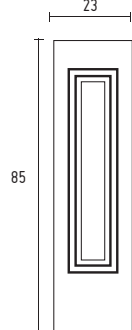

9403

Épaisseur : 4,5 cm
Stylobates

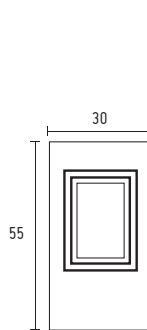

9411

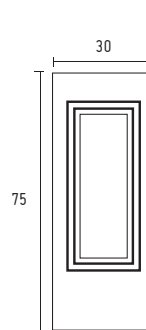

9412

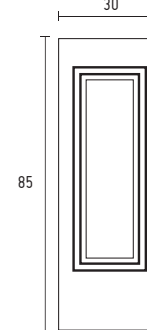

9413



Pensez à composer :
Découvrez tous nos modèles de plinthes à la page 103
de notre catalogue !



NOS AUTRES SOLUTIONS POUR VOS SOUBASSEMENTS

Une cinnaise



un panneau



une plinthe



1140C (en 1,50 ml)



1141C (en 1,50 ml)



9315C (en 1,50 ml)



9020 - H 118 x L 70 cm



9021 - H 86 x L 70 cm



9211 - H 75 x L 30 cm



9025 - H 120 x L 32 cm

Nos autres modèles de cinquaises



1101C (en 1,50 ml)



1103C (en 1,50 ml)



1145C (en 1,50 ml)



SDC1 (en 1,20 ml)
Conditionnement en carton de 4 éléments



SDC2 (en 1,20 ml)
Conditionnement en carton de 4 éléments

*Sélectionnez votre profil
& choisissez la dimension
de votre panneau !*

Profil n°1



Profil n°2



Profil n°3



RÉFÉRENCE DES PANNEAUX			
Dimensions en cm	80x50	55x50	20x50
Profil n°1	9001	9003	9002
Profil n°2	9011	9013	9012
Profil n°3	9031 (83X50)	9033	9032

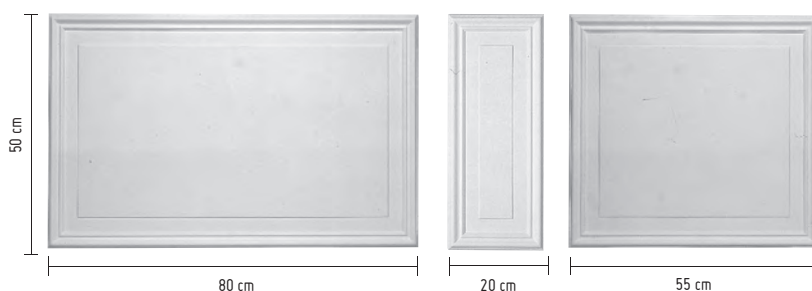

Nos modèles de plinthes

PLIN08 (en 1,50 ml), hauteur 8 cm
 PLIN10 (en 1,50 ml), hauteur 10 cm
 PLIN12 (en 1,50 ml), hauteur 12 cm
 PLIN15 (en 1,50 ml), hauteur 15 cm
 PLIN20 (en 1,50 ml), hauteur 20,5 cm



Angles sortants :
 PLIN10A (pour PLIN10)
 PLIN12A (pour PLIN12)
 PLIN15A (pour PLIN15)
 PLINTA (pour PLINT)



PLINT (en 1,50 ml), hauteur 10 cm

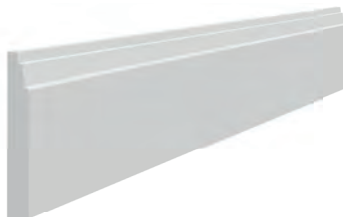

PLIN08M (en 1,50 ml), hauteur 8 cm
 PLIN10M (en 1,50 ml), hauteur 10 cm



LES HABILLAGES DE PORTE

LE CONTEMPORAIN



HABILLAGE DE PORTE 960.00

3 panneaux imbriqués de 65 x 20 cm.
Convient aux portes de toute largeur.



Mise en oeuvre

- Poser la porte sur 2 tréteaux.
- Exécuter un tracé sur la porte pour déterminer l'emplacement exact des panneaux à coller.
- Poncer à l'aide de gros papier de verre pour éliminer les fonds de peinture et rayer au cutter pour faciliter l'accrochage.
- Sur le panneau d'habillage de porte, appliquer de la colle pour carrelage référence 0034 (en 5 kg) ou 0036 (en 1,5 kg) à l'aide d'une spatule à dents.
- Procéder au raclage des bavures, dès que la colle a commencé à faire sa prise.

La finition de ces panneaux vous évitera tout ponçage et préparations diverses avant l'application de la peinture.



HABILLAGÉ DE PORTE 912.73



Habillage de porte 902.73,
couvre joint 1108,
fronton de Porte,
moulure 1156.



Profil n°1



Profil n°2



Profil n°3

RÉFÉRENCES DES DIFFÉRENTS MODÈLES							
TYPE DE PROFIL	LARGEUR DES PORTES						
Profil n°1	63 cm	901.63	911.63	921.63	930.63	940.63	950.63
	73 cm	901.73	911.73	921.73	930.73	940.73	950.73
	83 cm	901.83	911.83	921.83	930.83	940.83	950.83
Profil n°2	63 cm	902.63	912.63	922.63	932.63	942.63	952.63
	73 cm	902.73	912.73	922.73	932.73	942.73	952.73
	83 cm	902.83	912.83	922.83	932.83	942.83	952.83
Profil n°3	63 cm	903.63	913.63		933.63	943.63	
	73 cm	903.73	913.73		933.73	943.73	
	83 cm	903.83	913.83		933.83	943.83	

LES COUVRE-JOINTS

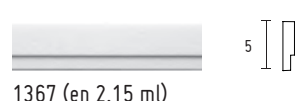
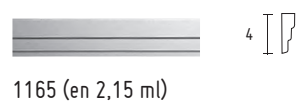
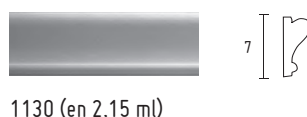
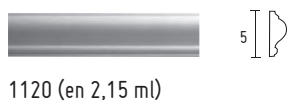
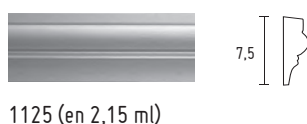
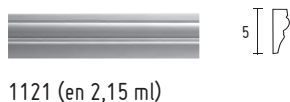
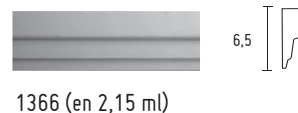

LES TALONS DE PORTE

TAL12 :
H 12 cm, L 6 cm, E 2 cm
TAL14 :
H 14 cm, L 6 cm, E 2 cm
TAL17 :
H 17 cm, L 6 cm, E 2 cm

TALGM
H 17 cm, L 9 cm, E 3,5 cm
TALSP
H 14 cm, L 7,5 cm, E 2,2 cm

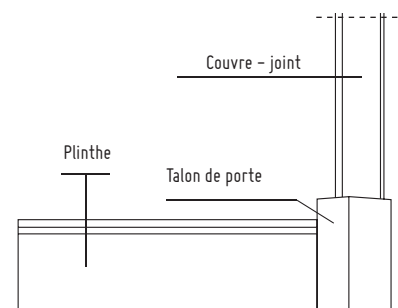

D'autres talons de portes adaptés à vos moulures sont disponibles en magasin. Renseignez-vous auprès de votre conseiller Staff Décor !

LES FRONTONS



3900 - 101 x 31 cm



3902 - 99 x 36 cm



3905 - 79,5 x 42
livré finition plâtre naturel



Nos frontons vous sont livrés brut de plâtre. N'hésitez pas à les personnaliser et les adapter aux couleurs de votre intérieur en les peignant !



FRONTON 3903
© The White House, Cannes



3904 - 100 x 22 cm



3901 - 112 x 30 cm



3903 - 120 x 45 cm

LES COLONNES



40.06
24 x 24 x H 11 cm
40.60, 1/2 chapiteau



40.07
24 x 24 x H 13 cm
40.70, 1/2 chapiteau



40.03
Ø 29,5 cm - H 13 cm
40.30, 1/2 chapiteau



40.08
29 x 29 x H 24 cm
40.80, 1/2 chapiteau



40.09
24 x 24 x H 8 cm
40.90, 1/2 chapiteau



40.01
46 x 46 x H 40 cm
40.10, 1/2 chapiteau



40.04
30 x 30 x H 10 cm
40.40, 1/2 chapiteau



40.07A
29 x 29 x H 13 cm
40.70A, 1/2 chapiteau



20.05
H 200 cm
sous collerette
Ø haut 14 cm
Ø base / 19 cm

20.55
1/2 col.
H 205 cm

Socle :
25 x 25 x 30 cm



20.04
H 200 cm
sous collerette
Ø haut 14 cm
Ø base / 19 cm

20.54
1/2 col.
H 205 cm

Socle :
25 x 25 x 30 cm



20.02
H 220 cm
sous collerette
Ø haut 20 cm
Ø base / 26 cm

20.52
1/2 col.
H 220 cm

Socle :
35 x 35 x 50 cm



Mise en oeuvre

- Pour habiller un poteau nos colonnes sont livrées par deux 1/2 colonnes à assembler
- L'ajustement de la colonne à la hauteur désirée se fait par réduction de la hauteur du socle ou encore de son fût.

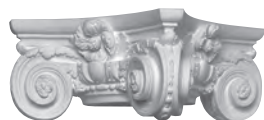

40.02
41 x 41 x H 16,5 cm
40.20, 1/2 chapiteau



40.01
46 x 46 x H 40 cm
40.10, 1/2 chapiteau



40.05
34 x 34 x H 10 cm
40.50, 1/2 chapiteau



20.03
H 220 cm sous collerette
ø haut 21,5 cm
ø base / 27 cm

20.53
1/2 col
H 220 cm

Socle : 35 x 35 x 50 cm







20.01
H 220 cm
ø 25 cm

20.51
1/2 col.
H 220 cm

Socle : 35 x 35 x 50 cm

Composez vos colonnes !

A l'aide de notre tableau de correspondances, choisissez les éléments qui s'adapteront à votre intérieur !

	DIAMETRE	DIMENSIONS colonne entière H x L x l	LISSES			HAUTEUR (en cm)	CANNELEES					
			½	ENTIERE			½	ENTIERE				
CHAPITEAUX 	Ø 15	11x24x24	40.60	40.06	CHAPITEAUX 		40.60	40.06				
	Ø 20	10x30x30	40.40	40.04			40.40	40.04				
	Ø 25	10x34x34	40.50	40.05			40.50	40.05				
	Ø 30	11,5x40x40	41.51	41.01			41.51	41.01				
	Ø 35	12,5x46x46	41.55	Nous consulter			41.55	Nous consulter				
	Ø 40	11 x 52 x 52	41.52	41.02			41.52	41.02				
	Ø 50	13 x 63 x 63	41.53	41.03			41.53	41.03				
FÛTS LISSES 	Ø 10	250	20.58	20.08	FÛTS CANNELES 	250	20.56	20.06				
	Ø 15	300	30.52	30.02		250	31.51	31.01				
	Ø 20	300	30.53	30.03		300	31.52	31.02				
	Ø 25	300	30.54	30.04		300	31.53	31.03				
	Ø 30	300	30.55	30.05		300	31.54	31.04				
	Ø 35	300	30.56	30.06		300	Nous consulter	Nous consulter				
	Ø 40	300	30.57	30.07		300	-	-				
	Ø 50	300	30.58	30.08		300	-	-				
	Ø 60	300	30.59	30.09		300	-	-				
	Ø 70	300	30.60	30.10		300	-	-				
	Ø 75	300	30.61	30.11		300	-	-				
	Ø 80	300	30.62	30.12		300	-	-				
	Ø 90	300	30.63	-		300	-	-				
SOCLES & COLLERETTES 		DIM. ENTIER	COLLERETTE	SOCLE	COLLERETTE	SOCLE	SOCLES & COLLERETTES 	Hauteur	COLLERETTE	SOCLE	COLLERETTE	SOCLE
	Ø 10	14,5x14x14	20.56B	20.56S	20.06B	20.06S		14,5	20.56B	20.56S	20.06B	20.06S
	Ø 15	39 x 25 x 25	45.51		45.01			39	45.51		45.01	
	Ø 20	31 x 32 x 32	45.52		45.02			31	45.52		45.02	
	Ø 25	61 x 35 x 35	45.53		45.03			61	45.53		45.03	
	Ø 30	41 x 42 x 42	45.54		45.04			41	45.54		45.04	
	Ø 35	Nous consulter	45.55		45.05			Nous consulter	45.55		45.05	
	Ø 40		45.56		45.06				45.56		45.06	
Ø 50	45.57			45.07		45.57			45.07			

Dimensions en cm



Les socles peuvent être coupés en hauteur.



FÛT 20.02
CHAPITEAU 40.01
PAGE 108

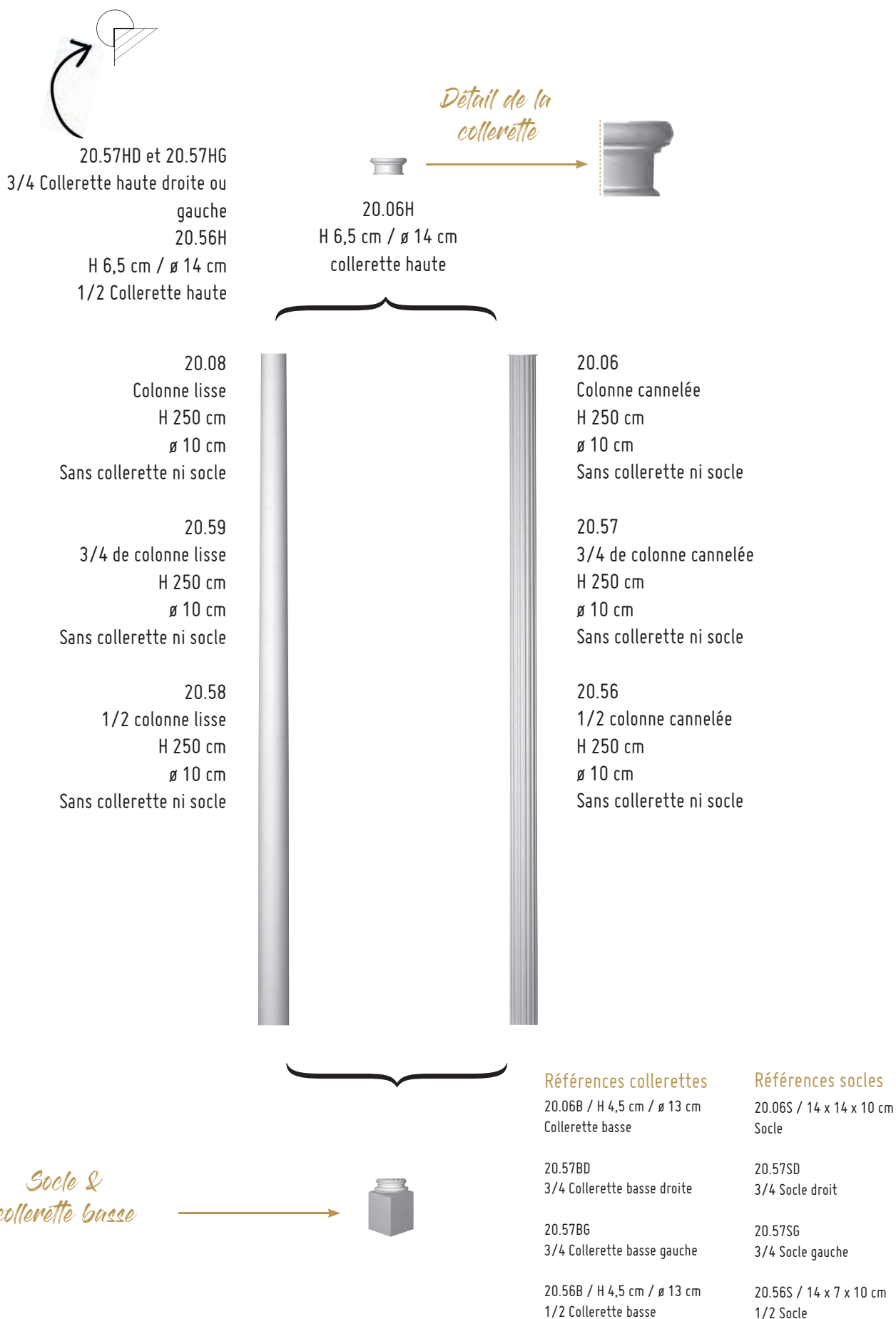

Mémo mise en oeuvre

Attention : Les socles et collerettes basses sont dissociés.

Aussi pour toutes vos commandes, veuillez à bien sélectionner toutes les références nécessaires.



2001
H 8 x L 40 x E 6 cm



2004
H 15 x L 43,5 x E 10 cm



2000
H 250 cm x L 30 cm x E 3 cm

2020
H 244 cm x L 30 cm x E 2,5 cm



2005
H 30 cm x L 39 cm x E 7 cm



PILASTRE 2020

LES PILASTRES



1001
H 8 x L 33,5 x E 6 cm



1002
H 34 x L 36 x E 10 cm



1003
H 24 x L 40 x E 11 cm



1004
H 15 x L 37 x E 10 cm



1055
H 28,5 x L 34,5 x E 10 cm



0999
H 17 x L 41 x E 12 cm



1000
H 250 cm x L 23 cm x E 3 cm



1025
H 250 cm x L 23 cm x E 3 cm



Notre fleur de
trumeau existe
aussi seule :
3906



1050
H 250 cm x L 23 cm x E 3,5 cm



1005
Pour pilastres 1000, 1025, 1050 et 2031
H 30 cm x L 31 cm x E 7 cm



0952
H 15,5 x L 26 x E 6,6 cm



0951
H 8 x L 29,5 x E 6 cm

Personnalisez vos pilastres avec nos ornements centrales !



2030M : Rectangle central pour pilastre 2030



2031C : Cercle central pour pilastre 2031



2031M : Rectangle central pour pilastre 2031

*égale-
ment
compatible*



Ce pilastre existe également en 40 cm de largeur pour une hauteur de 250 cm sous la référence 3000.



0950
H 250 cm x L 19 cm x E 3,5 cm

2030
H 170 cm x L 17 cm x E 1,5 cm



0955
H 24,5 cm x L 24,5 cm x E 6 cm

Existe aussi
2031
H 170 cm x L 23 cm x E 1,5 cm



0761
H 9 x L 12 x E 4 cm



0801
H 8 x L 22,5 x E 4,5 cm



0802
H 18 x L 22,5 x E 6 cm



0803
H 9 x L 17 x E 4 cm



0762
H 4,5 x L 13 x E 4 cm



0804
H 15 x L 26 x E 9 cm



0806
H 5,5 x L 19 x E 5 cm



0760
H 250 cm x L 7 cm x E 1,5 cm



Autre modèle de pilastre
cannelé Réf. 0780
(H 250 cm, L 10 cm, E 1,5 cm)
avec têtes 0781 ou 0782
et socle 0785.



0800
H 250 cm x L 12 cm x E 2 cm



0765
H 17 cm x L 9,5 cm x E 3 cm



0805
H 17,5 cm x L 14,5 cm x E 3 cm

LES BALUSTRES



0901

H 9,5 x L 22 x E 4,5 cm



0902

H 14,5 x L 26 x E 7 cm



0903

H 15,5 x L 31 x E 9 cm



0904

H 8 x L 26 x E 5 cm



0900

H 250 cm x L 17 cm x E 2,5 cm



0905

H 21 cm x L 20 cm x E 4 cm

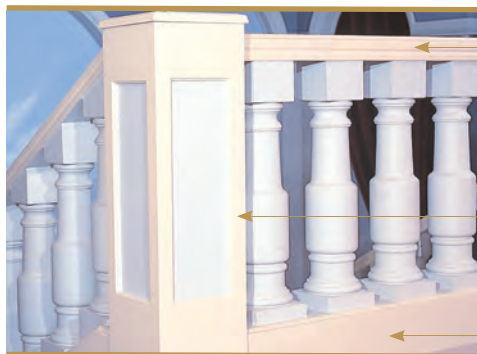

7004

Main courante
L 14,5 x 7 cm
(en 2 ml)

7006

Poteau
25 x 25 x H 95 cm

7005

Socle
L 23,5 x 26 cm
(en 2 ml)



Balustre 1

7001

H 60 cm

Base

15,5 x 15,5 cm



Balustre 3

7003

H 80 cm

Base

16,5 x 16,5 cm



Balustre 2

7002

H 60 cm

Base

15,5 x 15,5 cm

MEUBLE MODULOSTAFF
PAGE 124



CACHE RADIATEUR
PAGE 148



CORNICHE D575
PAGE 19

PASSAGE ÉCLAIRANT
PAGE 143

PAREMENT CAPITON
7072
PAGE 82

LES AGENCEMENTS



	LE MODULOSTAFF & LES NICHES	122
	ÉLÉMENTS CREUX POUR MODULO	124
	ÉLÉMENTS D'ANGLES EN QUART DE ROND POUR MODULO	125
	ÉLÉMENTS PLEINS POUR MODULO	127
	LES NICHES CONTEMPORAINES	128
	LES NICHES CLASSIQUES	129
	LES NICHES GRANDES DIMENSIONS	129

	LES TÊTES DE LIT	130
	TÊTE DE LIT OCÉAN	130
	TÊTE DE LIT CAPITONS	130
	TÊTE DE LIT SAHARA	131

	LES MEUBLES EN STAFF	132
	MEUBLES TV	132
	BIBLIOTHÈQUES	133
	MEUBLES BIBLIOTHÈQUES	134
	MEUBLES ET DÉCORS DE SALLE DE BAIN	136

	LES PASSAGES ET MEUBLES DE PASSAGE	138
	LES PASSAGES CLASSIQUES	140
	LES VOUTES	141
	LES PASSAGES CONTEMPORAINS	142
	LES PASSAGES ÉCLAIRANTS	143
	LES MEUBLES DE PASSAGE	144

	LES CACHE RADIATEURS	146
	LES CONTEMPORAINS	148
	LES CLASSIQUES	149



MODULO MOD23
PAGE 124

LE MODULOSTAFF & LES NICHE



NICHE
PAGE 128





Simplifiez-vous la vie !

Faites passer vos gaines techniques dans les éléments creux pour l'alimentation de vos spots et LEDS ou votre matériel HIFI !

MODULEZ EN FONCTION DE VOS BESOINS !

Associez nos accessoires à nos éléments creux et obtenez un meuble sur-mesure à votre image !

ÉLÉMENTS CREUX POUR MODULO

Montants verticaux (1)			
Réf.	Hauteur	Profondeur	Épaisseur
MOD23	250 cm	36 cm	5 cm
MOD24	250 cm	36 cm	7 cm
MOD25*	250 cm	36 cm	7 cm

* 4 faces lisses

Éléments horizontaux (étagères) (2)			
Réf.	Longueur	Profondeur	Épaisseur
MOE45	37,5 cm	35,5 cm	7 cm
MOE60	52,5 cm	35,5 cm	7 cm
MOE90	82,5 cm	35,5 cm	7 cm
MOE120	112,5 cm	35,5 cm	7 cm

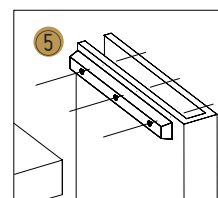
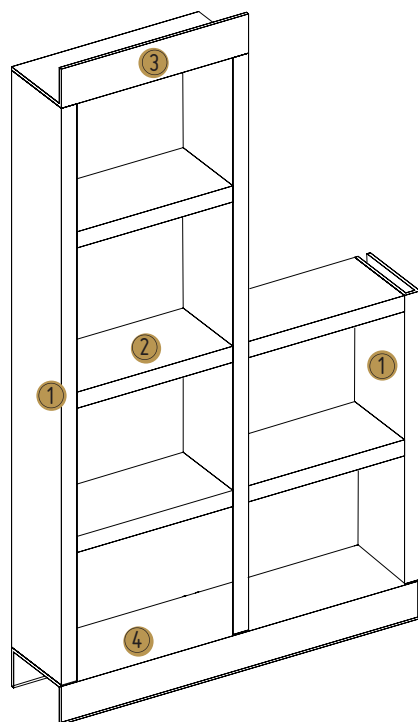

ACCESSOIRES OPTIONNELS

Casquette (3) MODC : hauteur : 17 cm, profondeur 36 cm en élément de 2 ml.

Socle (4) MODS : hauteur : 17 cm, profondeur 36 cm en élément de 2 ml.

Glissières (5) pour la fixation des étagères (vendues par 10 unités), pré-perçées, à visser et à coller à l'enduit.

MOD06 (pour MOD24 et MOD25)

MOD05 (pour MOD23)

ÉLÉMENTS D'ANGLE EN QUART DE ROND POUR MODULO

Mise en oeuvre :



L'étagère MOA24, le socle MOAS et la casquette MOAC permettent de créer des angles arrondis dans les compositions modulostaff de la gamme MOD24. De même rayon que la profondeur des éléments MOD24, leur pose sur glissières suit le même principe que pour les éléments droits.

ETAGERE (MOA23)

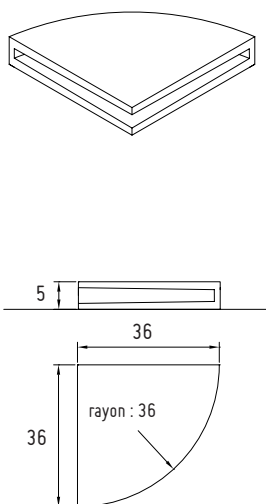

ETAGERE (MOA24)

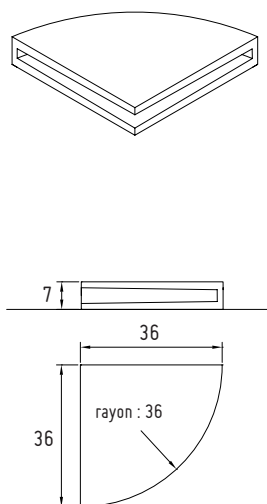

SOCLE (MOAS)

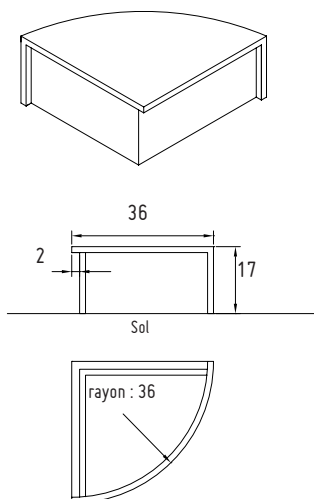

CASQUETTE (MOAC)

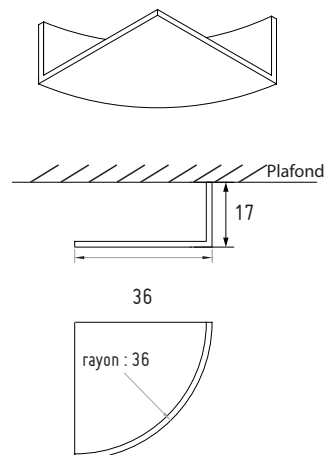

MODULO ARRONDI



Nous vous proposons des solutions de plinthes cintrées pour vos modulos: MOAPLIN10, MOAPLIN10M, MOAPLINT

COMMENT COMPOSER ?

Deux exemples pour tout comprendre et surtout s'inspirer !

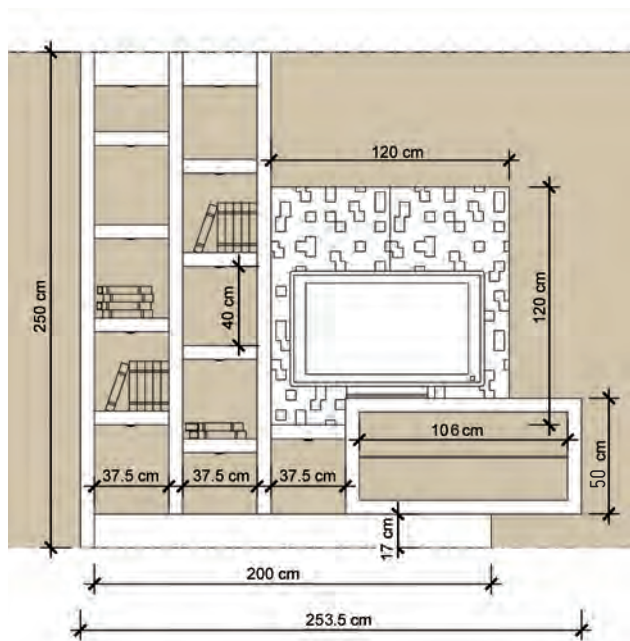

Composition pour TV et bibliothèque réalisée à partir de la gamme Modulostaff MOD24.



Réalisée à partir de la gamme Modulostaff MOD24, la composition "Quinconce" offre une solution de rangement contemporaine et rythmée. Accentuez le jeu de rythme grâce à l'alternance des éclairages.

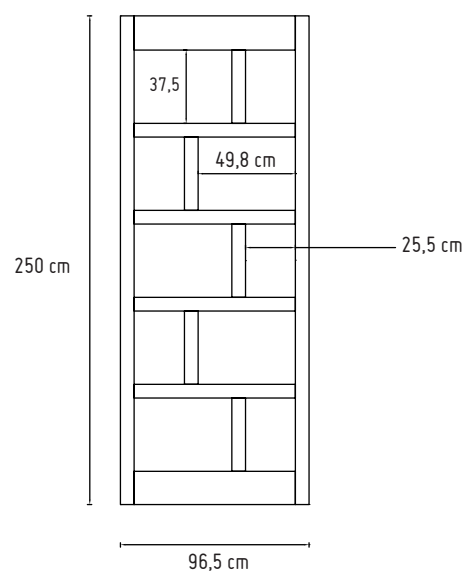

ÉLÉMENTS PLEINS POUR MODULO

Voici un concept de composants en staff en 5 cm d'épaisseur pour réaliser vos étagères.
Tous les éléments sont étudiés pour vous faciliter la pose.

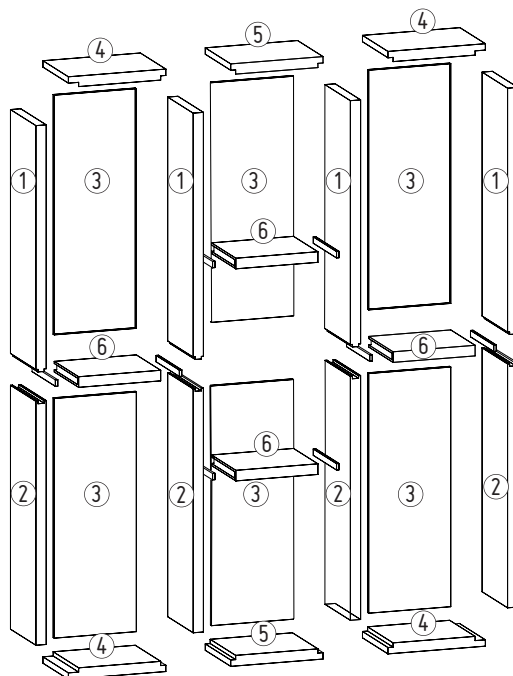
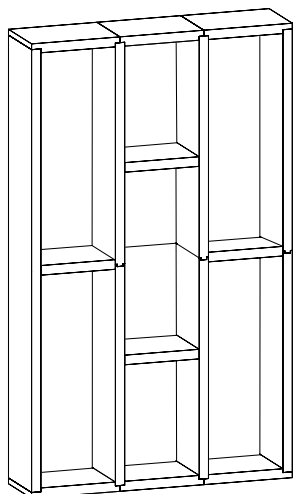

- 1 - M05-H115 : Montant (partie haute) 115 x 35 x 5 cm
- 2 - M05-B115 : Montant (partie basse) 115 x 35 x 5 cm
- 3 - M05-F0398 : Fond de meuble 111 x 39.8 x 1.5 cm
- 4 - M05-245 : Socle et/ou Casquette «Latéral» 47,3 x 35 x 5 cm
- 5 - M05-242 : Socle et/ou Casquette «Central» 44,8 x 35 x 5 cm
- 6 - M05-ET398 : Etagère 39,8 x 33,5 x 5 cm
- M05-545 : Socle / Casquette 50 x 35 x 5 cm (dans le cas d'un agencement avec une seule niche)
- MOD05 : glissières pour fixation des étagères (vendues par 10 unités)



LES NICHES CONTEMPORAINES



0714 / 40 cm x 20 cm x P 20 cm
0734 / 50 cm x 25 cm x P 20 cm
0744 / 60 cm x 30 cm x P 20 cm



0724 / 40 cm x 40 cm x P 20 cm



0726 / Ø 40 cm x P 20 cm

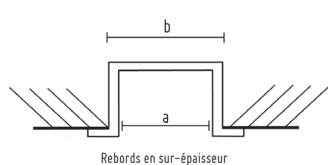

Niche à rebord



OU

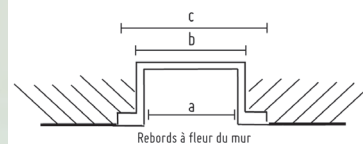

Niche à fleur

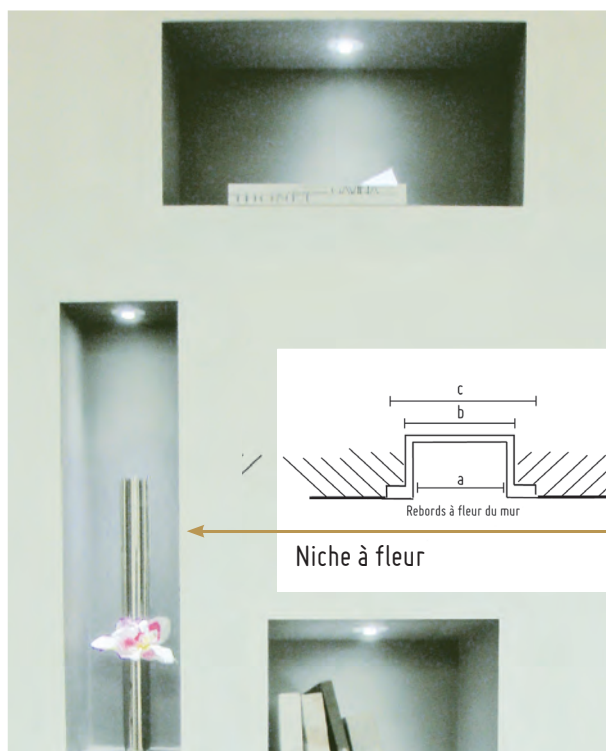

NICHES RECTANGULAIRES ET CARRÉES									
Réf.	Côtés intérieurs (a)			Côtés extérieurs d'encastrement (b)			Côtés extérieurs hors tout (c)		
	Hauteur	Largeur	Profondeur	Hauteur	Largeur	Profondeur	Hauteur	Largeur	Profondeur
0714	400	200	200	430	230	215	500	300	235
0724	400	400	200	430	430	215	500	500	235
0734	500	250	200	530	280	215	600	350	235
0744	600	300	200	630	330	215	700	400	235

Cotation en mm

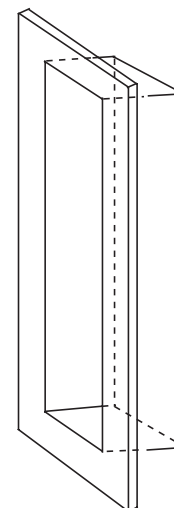

LES NICHES CLASSIQUES «CUL DE FOUR»

NICHES STANDARD						
Réf.	Côtés intérieurs (a)			Côtés extérieurs d'encastrement (b)		
	Hauteur	Largeur	Profondeur	Hauteur	Largeur	Profondeur
0710	300	150	75	320	170	85
0712	400	200	100	420	220	110
0732	500	250	125	520	270	135
0742	600	300	150	620	320	160

Cotation en mm

NICHES MODULABLES EN HAUTEUR		
Côtés intérieurs (a)		
Hauteur	Largeur	Profondeur
1020	400	200
1750	500	250
1800	600	300
1450	700	350
2000	800	400
2000	900	450
2000	1000	500

Cotation en mm

Toutes ces niches sont modulables en hauteur (fabrication spéciale sur devis). Pour déterminer les côtés d'encastrement ajoutez environ 30 ou 40 mm.

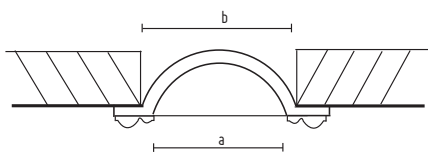

NICHE
CUL DE FOUR

LES NICHES GRANDES DIMENSIONS

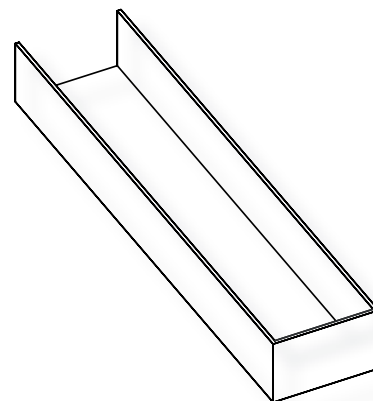
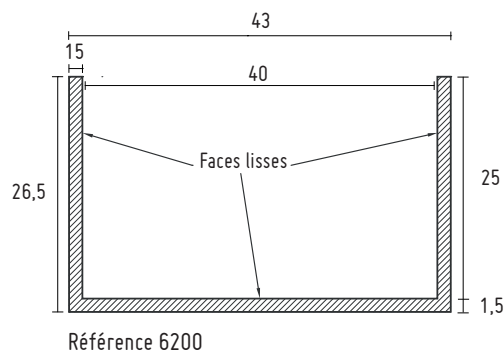
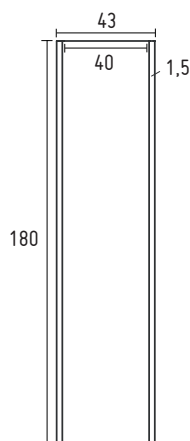

TÊTE DE LIT OCEAN

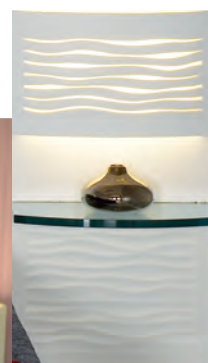

Deux largeurs standards de la partie centrale sont proposées :

- 160 cm (conseillée pour un lit de 140 cm) : T.OCEAN160
- 180 cm (conseillée pour un lit de 160 cm) : T.OCEAN180

Finition en plâtre naturel, prêt à peindre.

Pose par collage à l'enduit cellulosique.

Autres dimensions sur devis. Luminaires et ampoules inclus.

TÊTE DE LIT CAPITONS

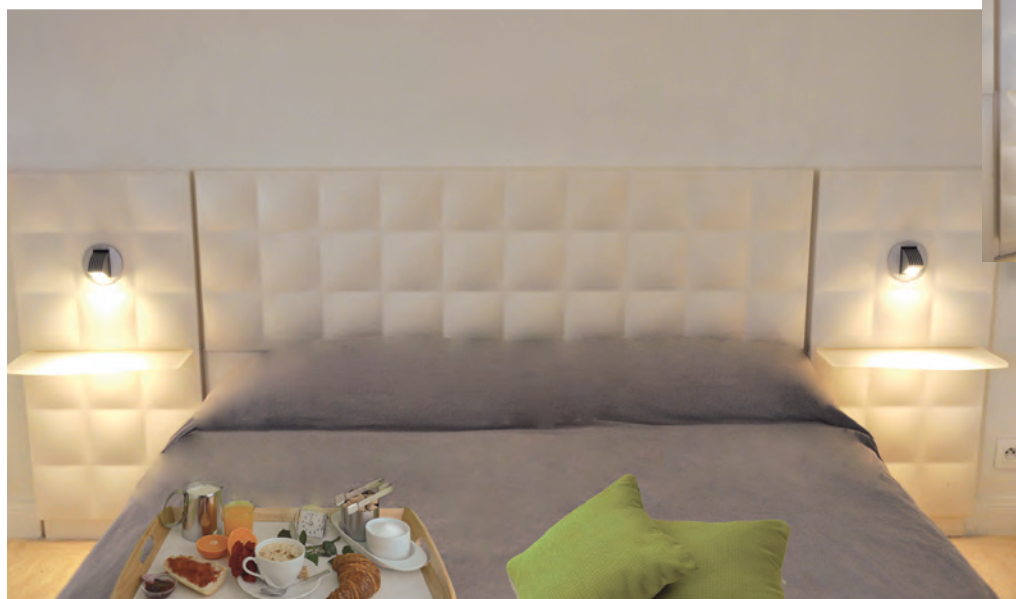

Deux largeurs standards de la partie centrale sont proposées :

- 165 cm (conseillée pour un lit de 140 cm) : T.CAPITON165
- 180 cm (conseillée pour un lit de 160 cm) : T.CAPITON180

Finition en plâtre naturel, prêt à peindre.

Pose par collage à l'enduit cellulosique.

Autres dimensions sur devis.

2 étagères en verre acrylique incluses.

Luminaires et ampoules non inclus.

TÊTE DE LIT SAHARA

Dimensions

Trois largeurs standards de la partie centrale sont proposées :

- 240 cm (conseillée pour lit de 140 cm) : T.SAHARA140
- 260 cm (conseillée pour lit de 160 cm) : T.SAHARA160
- 280 cm (conseillée pour lit de 180 cm) : T.SAHARA180

> Hauteur : 130 cm

> Profondeur : 8 cm (hors chevets)

Equipement

- > 3 éléments en staff
- > Ruban LED blanc chaud ou blanc froid
- > Alimentation A.OT20/24
- > 2 rails de 2ml AA-R1707 et déflecteur opaque.

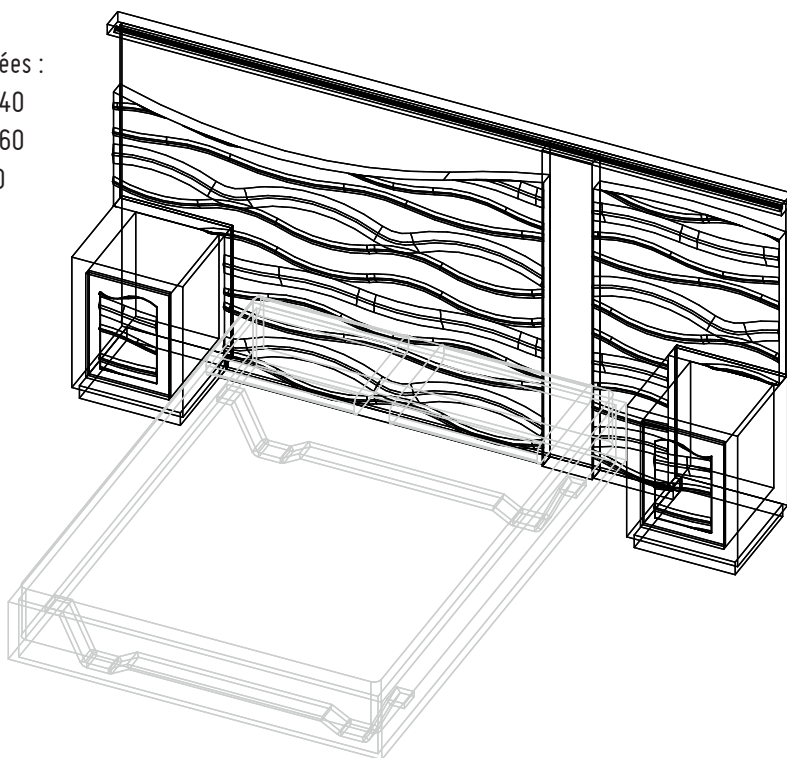

Option chevet :

> CHEVET1 (chevet avec étagère en verre),

Profondeur totale 28,5 cm

> CHEVET2D (chevet avec porte droite),

Profondeur totale 28,5 cm

> CHEVET2G (chevet avec porte gauche),

Profondeur totale 28,5 cm

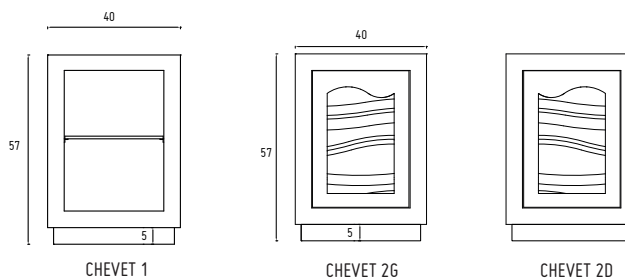

Lorsque l'option chevet est demandée, les réservations nécessaires à la pose sont créées en atelier.



MEUBLES TV CONTEMPORAINS

Le Meuble TV contemporain est composé de deux éléments. L'élément supérieur est posé sur celui du dessous en fonction de l'écartement souhaité.

Nous proposons 4 dimensions d'étagères en verre :

44,5 cm, réf. 22160.445

54,5 cm, réf. 22160.545

60,5 cm, réf. 22160.605

67,5 cm, réf. 22160.675

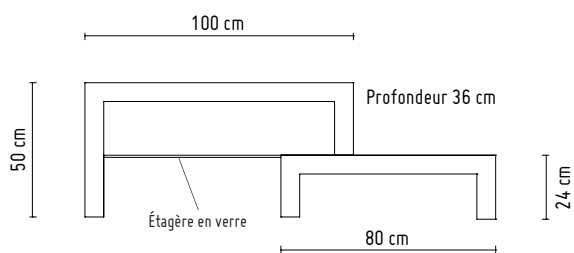

Meuble TV de style contemporain composé de quatre éléments en staff pré-monté (3 niches et un socle) à assembler par collage. Finition des éléments : plâtre naturel prêt à peindre.



Mise en oeuvre :
Assemblage par simple collage.

MEUBLES TV CLASSIQUES

MEUBLES TÉLÉ								
	1 Niche + TV		TV + 1 Niche		1 Niche + TV + 1 Niche		2 Niches + TV + 2 Niches	
Dimensions plateau en cm	191 x 44,5 avancée TV 64		191 x 44,5 avancée TV 64		248 x 44,5 avancée TV 64		362 x 44,5 avancée TV 64	
Hauteur meuble complet	248*		248*		248*		248*	
Référence colonnes cannelées	5001		5002		5003		5004	
Référence colonnes lisses	5011		5012		5013		5014	
Option accolée à un mur **	Gauche	Droit	Gauche	Droit	Gauche	Droit	Gauche	Droit
Référence colonnes cannelées	5021 G	5021 D	5022 G	5022 D	5023 G	5023 D	5024 G	5024 D
Référence colonnes lisses	5031 G	5031 D	5032 G	5032 D	5033 G	5033 D	5034 G	5034 D

* Possibilité d'adapter le meuble pour des hauteurs jusqu'à 300 cm (fabrication spéciale sur devis). Possibilité d'augmenter le nombre de niches du meuble TV (niche standard 57 x 44,5 cm). Les étagères en verre et les spots sont fournis avec les meubles. Étagères en verre : une par niche partie basse, trois par niche partie haute, une par niche TV. Spots : un par niche, deux par niche TV.

** Le côté droit ou gauche accolé au mur est déterminé en regardant le meuble de face.

LES BIBLIOTHÈQUES

Les bibliothèques sont composées de une ou plusieurs niches en staff de dimensions standards, livrées en kit, dont les éléments sont ajustés, collés à l'enduit lors du montage et prêts à peindre.

STAFF DÉCOR propose deux modèles de niches :

- Niche décorée par des colonnes cannelées
- Niche décorée par des pilastres cannelés

Une fois peintes, les bibliothèques s'intègrent harmonieusement dans votre décoration.





BIBLIOTHÈQUES AVEC PILASTRES				
	1 Niche	2 Niches	3 Niches	1 Niche supplémentaire**
Dimensions du socle en cm	88 x 33	148 x 33	208 x 33	60 x 33
Hauteur meuble complet	260*	260*	260*	260*
Référence	30061	30062	30063	30069

* Possibilité d'adapter la bibliothèque à différentes hauteurs (fabrication spéciale sur devis).

** Possibilité d'augmenter le nombre de niches de la bibliothèque (niche standard).

Les étagères en verre, les spots ainsi que la corniche sont proposés en option.

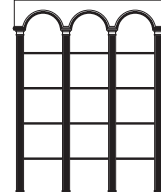

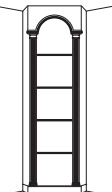
BIBLIOTHÈQUES AVEC COLONNES					
					
	1 Niche	2 Niches	3 Niches	1 Niche supplémentaire**	1 Niche d'angle***
Dimensions du socle en cm	70 x 32	130 x 32	190 x 32	60 x 32	80,5 x 80,5
Hauteur meuble complet	260*	260*	260*	260*	260*
Référence	30051	30052	30053	30059	30054

* Possibilité d'adapter la bibliothèque à différentes hauteurs (fabrication spéciale sur devis).

** Possibilité d'augmenter le nombre de niches de la bibliothèque (niche standard).

*** Possibilité d'accoler des niches standards de chaque côté de la niche d'angle.

Les étagères en verre, les spots ainsi que la corniche sont proposés en option.

LES MEUBLES BIBLIOTHÈQUES



Comme les bibliothèques, le mobilier présenté ci-après, est constitué d'un ou plusieurs modules standard, livrés en kit, prêts à coller et à peindre.

Les éléments bas du mobilier STAFF DECOR, y compris les portes, sont fabriqués dans un matériau très résistant, constitué d'un mélange de plâtre, de fibre de verre et de résine, que nous avons appelé Résistaff (PMGRG - Norme EN.VF13815).

Les tableaux ci-après, présentent les références des éléments standards selon les options suivantes :

- colonnes lisses ou cannelées.
- meuble accolé à un mur sur son côté gauche ou droit, le côté droit ou gauche étant défini en regardant le meuble de face.

Ce système permet également la réalisation d'un meuble bibliothèque combinant des niches simples et d'angle (nous consulter pour la référence).

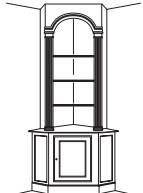
MEUBLES BIBLIOTHÈQUES									
									
	1 Niche		2 Niches		3 Niches		1 Niche d'angle		
Dimensions plateau en cm	79 x 44		136 x 44		193 x 44		90 x 90		
Hauteur meuble complet	248*		248*		248*		248*		
Référence colonnes cannelées	5041		5042		5043		5044		
Référence colonnes lisses	5051		5052		5053		5054		
Option accolée à un mur	Gauche	Droit	Gauche	Droit	Gauche	Droit	Gauche	Droit	
Référence colonnes cannelées	5061 G	5061 D	5062 G	5062 D	5063 G	5063 D	-	-	
Référence colonnes lisses	5071 G	5071 D	5072 G	5072 D	5073 G	5073 D	-	-	

* Sur devis possibilité d'adapter le meuble pour des hauteurs jusqu'à 300 cm (fabrication spéciale sur devis).

Possibilité d'augmenter le nombre de niches du meuble (niche standard 57 x 44 cm). Les étagères en verre et les spots sont fournis avec les meubles, (sauf pour les niches d'angle). Étagères en verre : une par niche partie basse, trois par niche partie haute. Spots : un par niche.



LES MEUBLES DE SALLE DE BAIN

STAFF DÉCOR propose un concept de décor de salle de bain composé d'arcades et de meuble en résistaff réalisés sur mesure. Devis et réalisation sur plan.

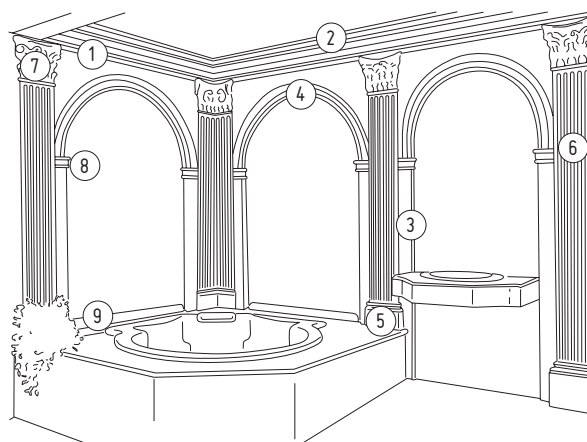

- | | |
|-----------------------|---------------------------------|
| 1 - Cornière 17 x 5 | 6 - Pilastre 23 cm, réf. 1050 |
| 2 - Corniche | 7 - Tête de pilastre, réf. 1055 |
| 3 - U largeur 45 cm | 8 - Moulure, réf. 1343 |
| 4 - Arcade sur-mesure | 9 - Moulure, réf. 1366 |
| 5 - Socle réf. 1005 | |



Dimensions :
longueur 210 cm,
profondeur : 65 cm.

Meuble de salle de bain. Différentes autres configurations sont possibles :

- Meuble avec 2 portes
- Meuble avec 2 portes et tiroirs ...

Le plateau peut être réalisé en Résistaff, marbre, verre, Corian (sur devis)



*Composez-vous même l'ambiance de votre salle de bain
à l'aide de nos produits !*



PILASTRE 1025
PAGE 114

CORNICHE D530
PAGE 36



PASSAGE ÉCLAIRANT
Motif CL10
PAGE 142

LES PASSAGES & MEUBLES DE PASSAGE

VOÛTE
PAGE 141



LES PASSAGES CLASSIQUES

Droit (1), en arc de cercle (2) ou en anse de panier (3), les habillages de passage, traits d'union de votre décoration, redessinent l'espace et s'intègrent harmonieusement dans tous les styles.

Le staff offre en plus, une grande variété de finitions.



Type 1



Type 2 (ADC)



Type 3 (ADP)

Largeur cm	DESSOUS DE POUTRE (passage type 1)				CÔTÉ DE PASSAGE(*)	
	Avec rond central		Avec rectangle central		Longueur 2.60 ml	Épaisseur 25 mm
	Longueur 2.50 ml	Épaisseur 25 mm	Longueur 2.50 ml	Épaisseur 25 mm	Longueur 2.60 ml	Épaisseur 25 mm
19	22104		22116		2019	
24	22105		22117		2024	
32	22106		22118		2032	
39	22107		22119		2039	
44	22108		22120		2044	
50	22109		22121		2050	
60	22110		22122		2060	
Sur mesure	Fabrication sur devis nous consulter				(*) Les côtés de passages peuvent également dans certains cas, être remplacés par des pilastres cannelés	

La longueur du dessous de poutre et des côtés de passage est ajustée en fonction des dimensions du passage existant, lors de la pose de ces éléments.



Avec rond ou rectangle central.

Habillage de passage type 1

- dessous de poutre réf. 22107
- côtés réf. 2039
- moulure réf. 1345

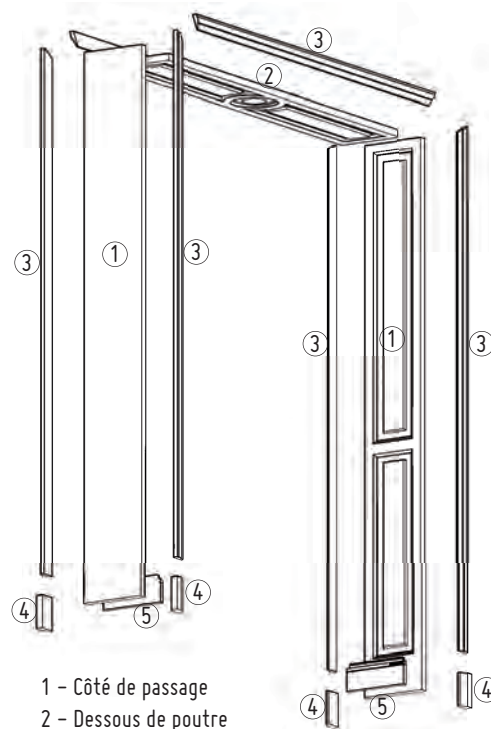

- 1 - Côté de passage
- 2 - Dessous de poutre
- 3 - Moulure
- 4 - Talon
- 5 - Plinthe



VOÛTE AVEC ROND CENTRAL

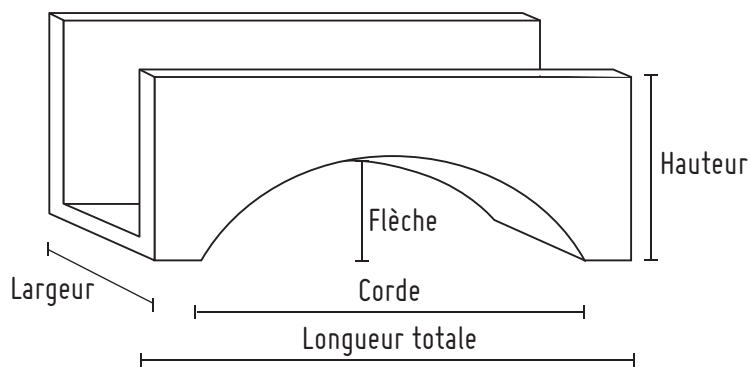

Fabrication en anse de panier ou en arc de cercle sur devis en fonction des dimensions de la voûte souhaitée : largeur, longueur, corde, flèche et hauteur.

- 1 - Côté de passage
- 2 - Voûte
- 3 - Moulure cintrée
- 4 - Moulure
- 5 - Talon
- 6 - Plinthe

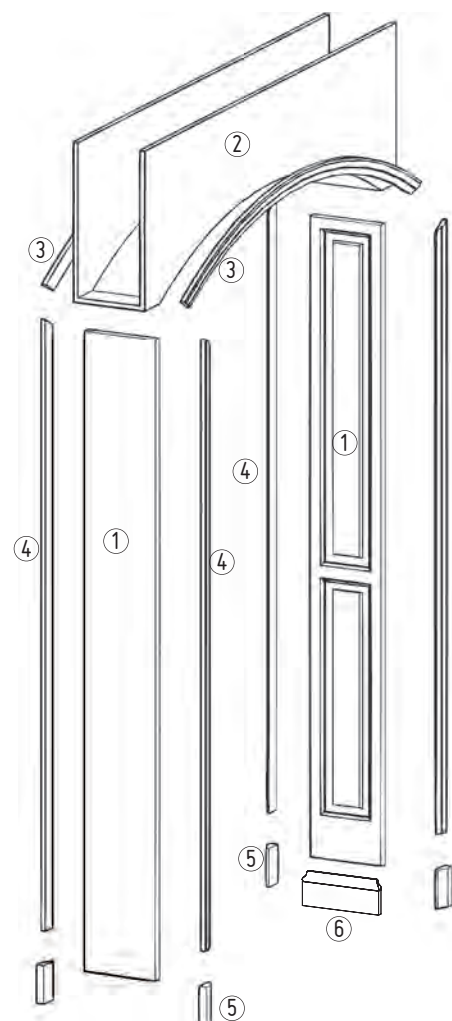

LES PASSAGES CONTEMPORAINS

Des habillages de passage qui apporteront une touche contemporaine à votre décor.

Différents modèles peuvent être utilisés pour le même passage. Par exemple, deux éléments avec le motif «Anneaux» (Réf.2618) pour les côtés du passage et un élément lisse (Réf. 2718) pour le dessous de poutre.

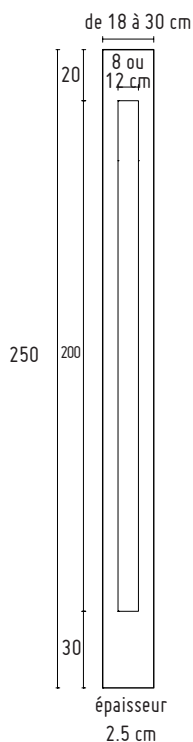

Sur mesure possible.

Décaissé lisse



2718
Largeur 18 cm
(décaissé central 8 cm)

2724
Largeur 24 cm
(décaissé central 12 cm)

2730
Largeur 30 cm
(décaissé central 12 cm)

Décaissé motif anneaux



2618
Largeur 18 cm
(décaissé central 8 cm)

2624
Largeur 24 cm
(décaissé central 12 cm)

2630
Largeur 30 cm
(décaissé central 12 cm)

Décaissé motif CL10



2518
Largeur 18 cm
(décaissé central 8 cm)

2524
Largeur 24 cm
(décaissé central 12 cm)

2530
Largeur 30 cm
(décaissé central 12 cm)

LES PASSAGES ÉCLAIRANTS

Habillage de passage conçu pour recevoir un ruban LED. L'éclairage met en valeur le motif (CL10, page 92) en soulignant son relief. Ce profil lumineux peut aussi être encastré dans votre mur ou plafond (Réf. 2800L).

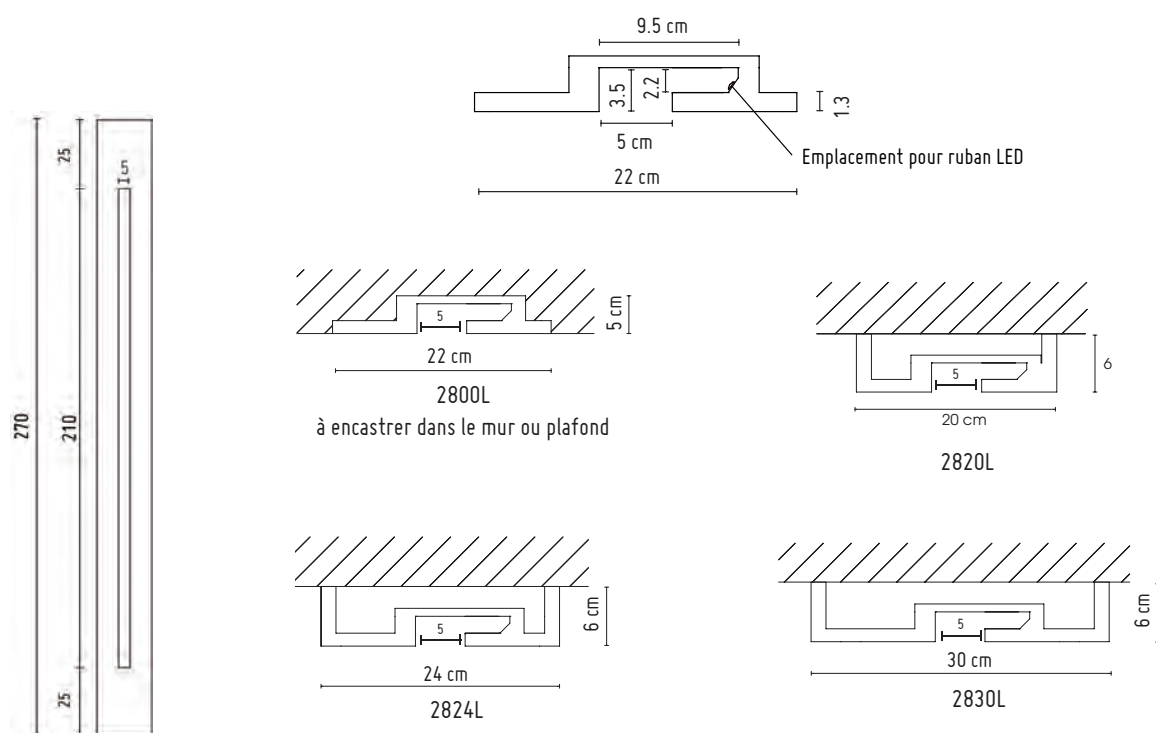

Autres dimensions possibles, nous consulter pour plus d'informations.



PASSAGE ÉCLAIRANT

LES MEUBLES DE PASSAGE

Envie de démarquer vos espaces de façon originale ?

Meuble passage de style contemporain, prêt à poser, livré en deux éléments :

- une partie basse pré-assemblée
- une colonne lisse, diamètre 20 cm



Laissez-vous guider & inspirez vous de nos compositions !

Élément complet avec étagères en verre et passage

OU

Élément de base avec sa colonne

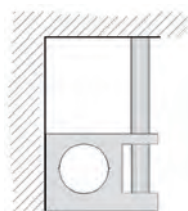
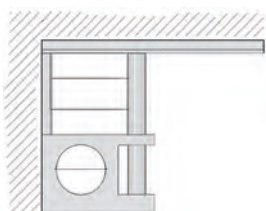

Visuel non contractuel.

22140	Ensemble meuble + colonne - Meuble assemblé avec colonne partie basse - Colonne partie haute : diamètre 20 cm - hauteur 200 cm (135 cm avec étagères + poutre)	
VER56	Etagère verre basse : 56 cm x 35 cm - ép. 8 mm	
U3225	Poutre 25 cm + 32 cm + 25 cm - en 200 cm	
OPT140	Dessous de poutre avec demi rond : diamètre 4cm - long 200 cm	
OPT141	Pilastre galbé avec réservation étagère 32 x 135 cm	
VER90	Etagère supérieure : 94 cm x 32 cm - ép. 8 mm	
SPOT	Spot GU 10 blanc 230 V avec ampoule GU10 Fluocompacte	

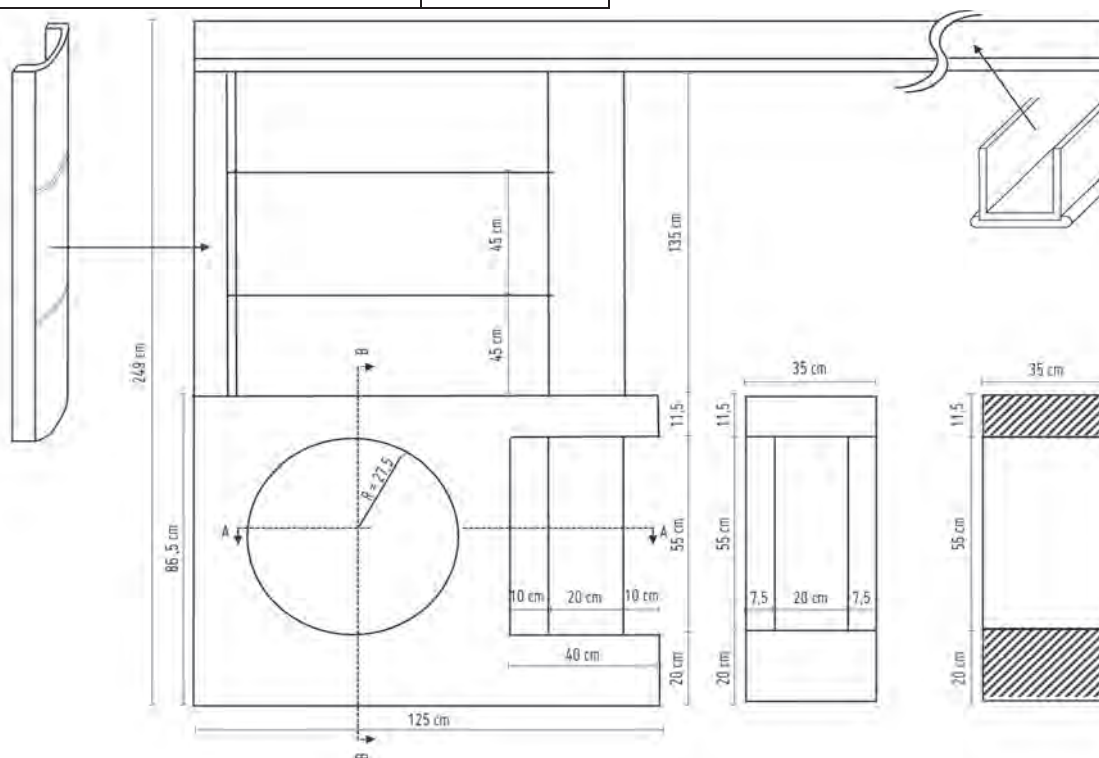

MEUBLES DE PASSAGE À ESPRIT ⊕ CLASSIQUE

PASSAGE AVEC MEUBLE DE SÉPARATION			
Cet ensemble référencé 22130M comprend les éléments suivants :			
N°	Désignation	Dimensions	Options
1	Voûte	Corde : 102 cm	- Sous face lisse
		Flèche : 30 cm	- Sous face décaissée
		Hauteur 50 cm	Moulure en forme (1125)
			Moulure en forme (1101)
2	Colonne conique avec encoches	Hauteur : 110 cm	- Lisse
			- Cannelée
3	Meuble bas 2 portes	Hauteur : 84 cm	Recto verso
		Largeur : 48 cm	Dos décaissé
		Longueur : 136 cm	/
4	└ dessous lisse	50 x 32 x 50 cm	/
5	Pilastre lisse avec encoches	Hauteur : 110 cm	/
		Largeur : 32 cm	
6	└ côté de passage	(L) longueur ajustable sur demande jusqu'à 250 cm	/
7	Côté de passage en décaissé	Hauteur : 194 cm	/
		Largeur : 32 cm	

Pour toutes commandes, précisez les options choisies et la dimension de (L).

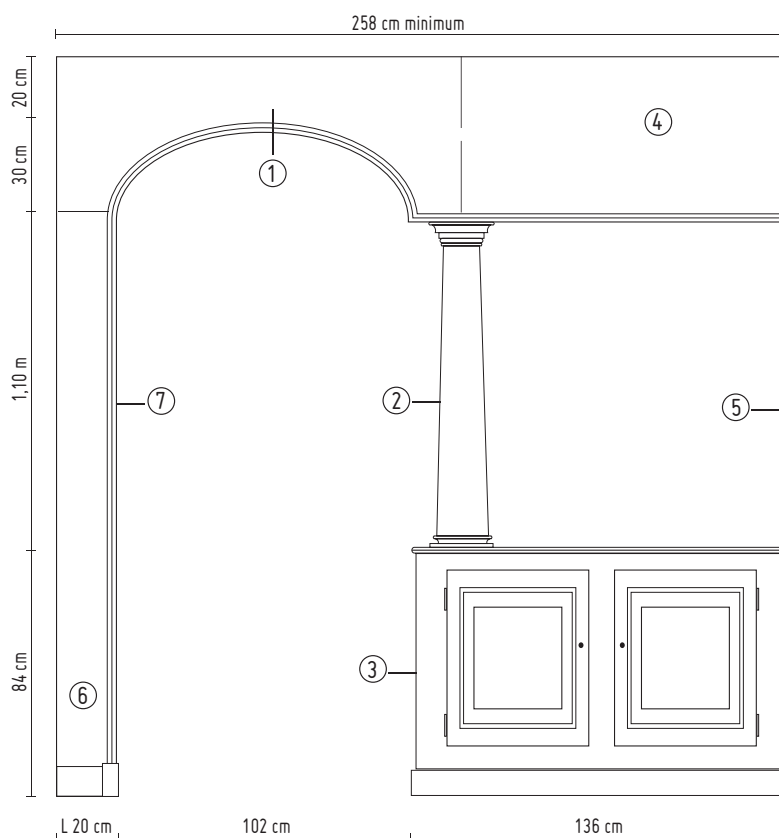



CACHE-RADIATEURS «RONS ALLÉATOIRES»
PAGE 148

LES CACHE- RADIATEURS

CACHE-RADIATEUR SUR-MESURE
DÉCOR CLASSIQUE
PAGE 149

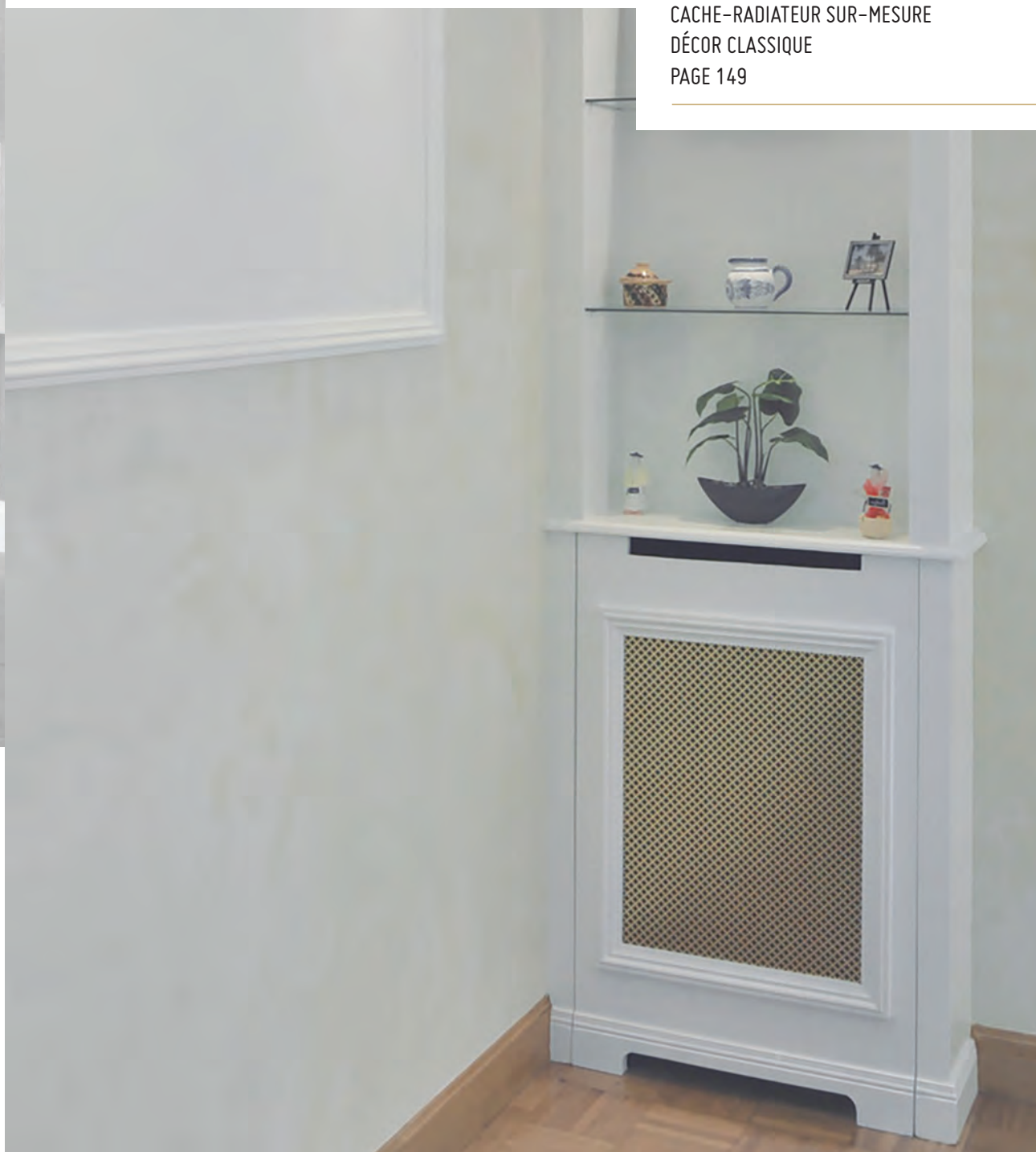

LES CONTEMPORAINS

Modèle « Constellation»
Design du motif par Sophie Briand

Avec sa forme épurée et ses motifs légers, le cache-radiateur «Constellation» s'intégrera avec discrétion et élégance dans votre intérieur. Dimensions sur mesure suivant le schéma ci-contre, motif toujours centré de mêmes dimensions. Possibilité d'installer un éclairage (ruban LED) derrière la façade.

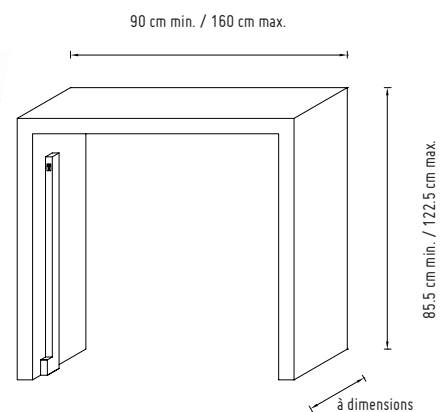

Modèle « Ronds aléatoires»

Fabrication sur mesure, préciser l'encombrement complet de votre radiateur, votre système de réglage compris. Possibilité d'installer un éclairage indirect (ruban LED) derrière la façade.

LES CLASSIQUES

Pour donner une touche déco à vos radiateurs, sans remettre en cause leur utilité, grâce à des ouvertures prévues pour la circulation de l'air chaud.

La façade amovible permet en outre l'accès au système de réglage du radiateur.

Fabrication sur mesure, préciser l'encombrement complet de votre radiateur, votre système de réglage compris, ainsi que les références de la moulure et la plinthe souhaitées (pour les cache-radiateurs classiques).

CACHE-RADIATEUR CLASSIQUE







← PARURE DE CHEMINÉE
98506
PAGE 152

LES CHEMINÉES

LES CLASSIQUES



Le saviez-vous?

Le staff est incombustible.

Quoi de plus naturel que de l'utiliser pour habiller vos foyers et hottes de cheminées ?



STYLE LOUIS XV

Réf. 98006

Trumeau (Hauteur sur mesure -max. 1,80m-, L 105 cm)

Réf. 98506

Parure de cheminée

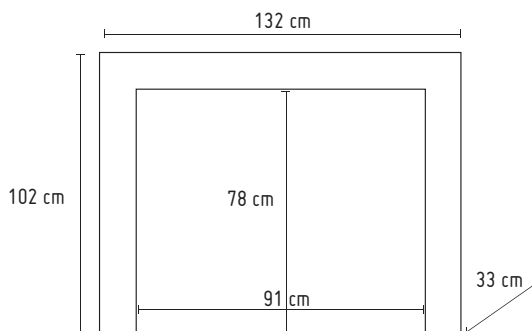

Réf. 98510, parure de cheminée Louis XV, grand modèle

Dimensions : hauteur : 118 cm, longueur : 155 cm, profondeur : 40 cm

Dimensions du trou à feu : longueur : 108 cm, hauteur : 96 cm



STYLE LOUIS XVI

Réf. 98000

Trumeau (Hauteur sur mesure -max. 1,80m-, L 103 cm)

Réf. 98500

Parure de cheminée

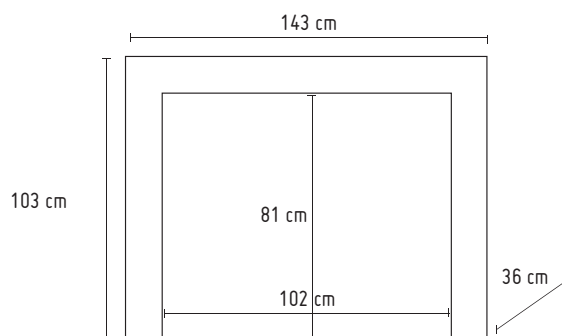

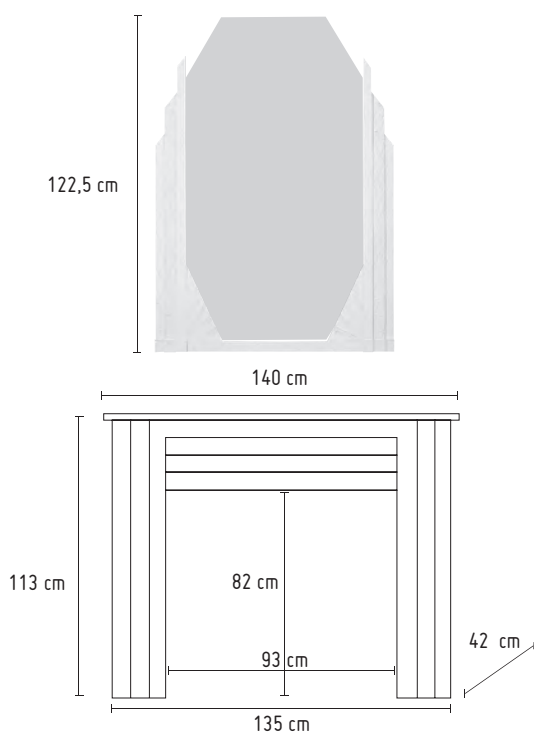

STYLE ART DÉCO

Réf. 97300
Miroir Art Déco,
(H. 122,5 cm, L 84,5 cm)

Réf. 98520
Parure de cheminée



LES CONTEMPORAINES

Réf. 98530
Parure de cheminée

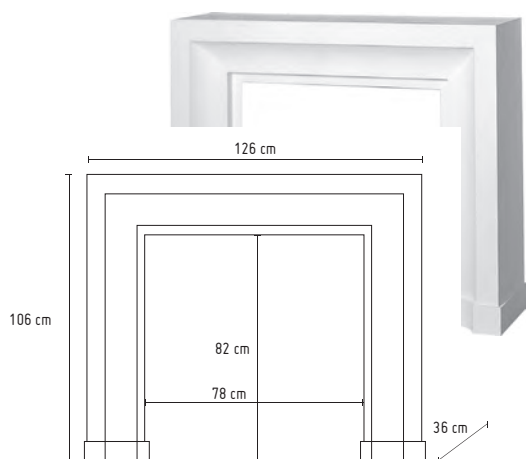

Réf. 98540
Parure de cheminée

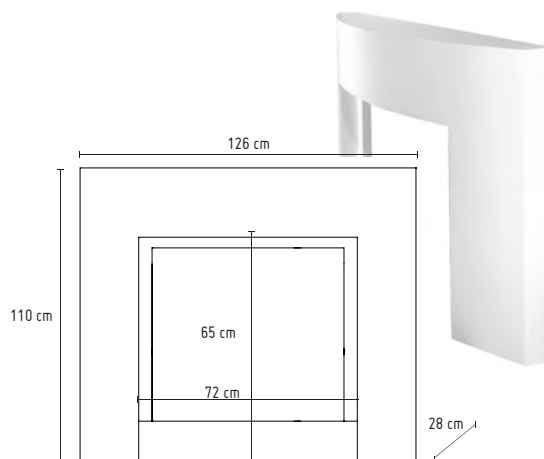





PLAFONNIER PL324F.BF
PAGE 156

LES LUMINAIRES



LES PLAFONNIERS

PL304 - 314 - 324

Plafonniers rectangulaires

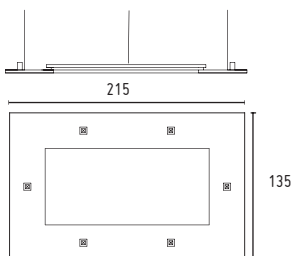

PL304

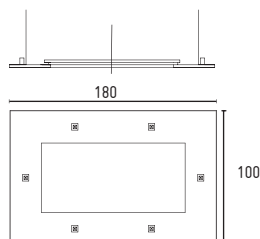

PL314

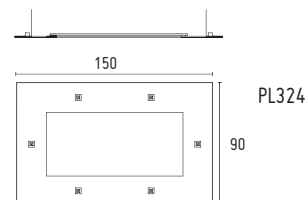

PL324



*Déterminez votre format
puis choisissez votre modèle
de plafonnier !*



PLAFONNIER
PL324F.BF

Rond, carré, rectangulaire...
Choisissez votre forme,
piochez un décor.
Plus d'une centaine
de combinaisons s'offre à vous !

Équipé de 6 spots carrés LED,
BC : 6 spots LED 3000 °K • 6 x 600 Lm • IRC 92
BF : 6 spots LED 4000 °K • 6 x 630 Lm • IRC 92
Partie centrale rétroéclairée par LED
B : LED bleu, C : LED blanc chaud 3000 °K,
F : LED blanc froid 6500 °K.
Rail Alu et ruban LED extérieur.
Suspendu par 4 fils métalliques.
Finition : impression blanche.
En option : Eclairage dimmable par radio.

BC : Blanc Chaud
BF : Blanc froid

PL222 & 223 Plafonniers circulaires

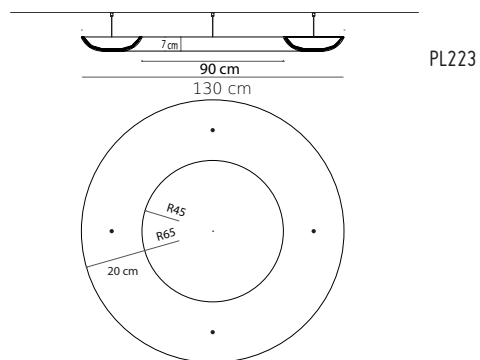
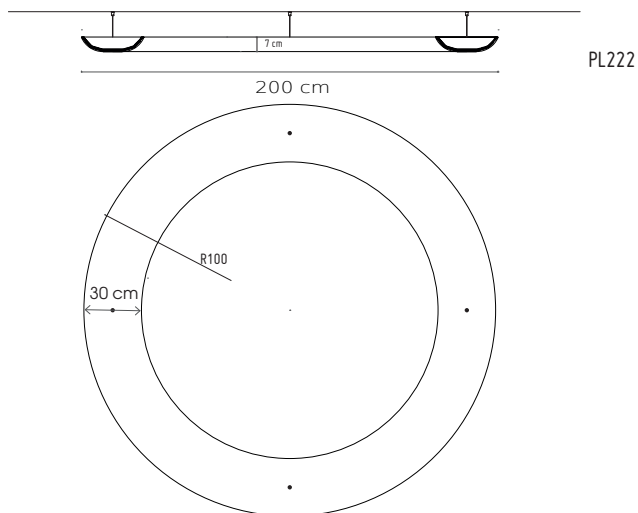

Partie centrale rétroéclairée par LED

BC : LED blanc chaud 3000 °K,

BF : LED blanc froid 6500 °K.

Suspendu par 4 filins métalliques.

Finition : impression blanche.



Retrouvez tous nos plafonniers
en flashant notre QR CODE !



PL621

Plafonniers suréquipés

80 x 60 x 5,4 cm

Poids : 8,5 kg

Entraxe de perçage :

40 x 30 cm



PLAFONNIER
PL621F.BF

Téléchargez notre catalogue luminaires sur
www.staffdecor.fr rubrique «Téléchargements»
en bas de notre site ou demandez le
auprès de votre conseiller Staff Décor !



*+ de 500 références
disponibles !*



LES APPLIQUES

APPLIQUES



APPLIQUES

64

L. 26,5 cm x P. 11 cm x H. 55 cm.

Équipement compatible : 57



02

L37,5 cm x P19,5 cm x H20,5 cm

Équipement compatible : 50BC, 50BF, 52, 56

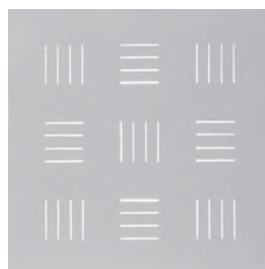

80

L36 cm x P8 cm x H36 cm

Équipement compatible : LED



100

L40 cm x P8 cm x H12 cm

Équipement compatible : 50BC, 50BF

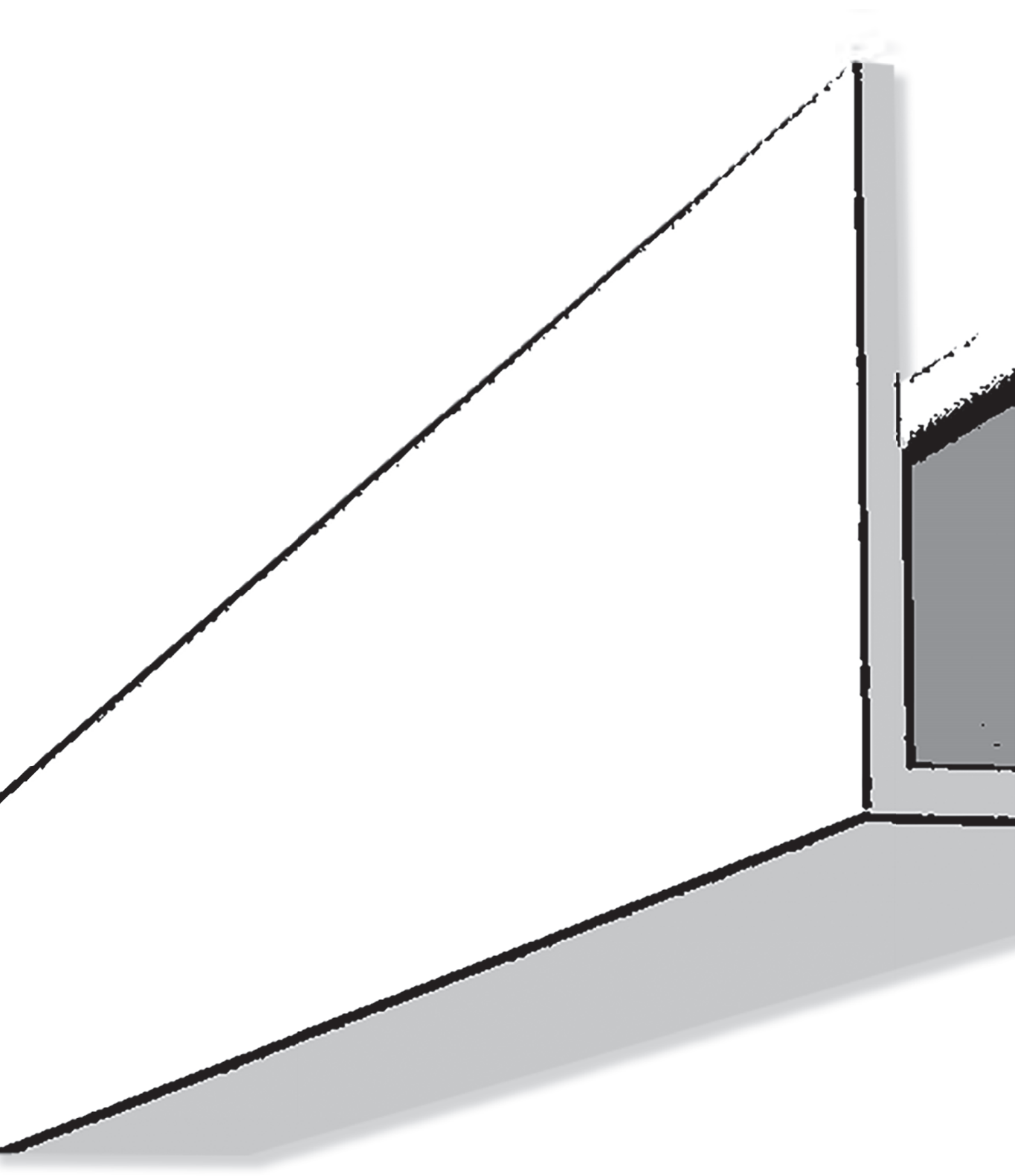

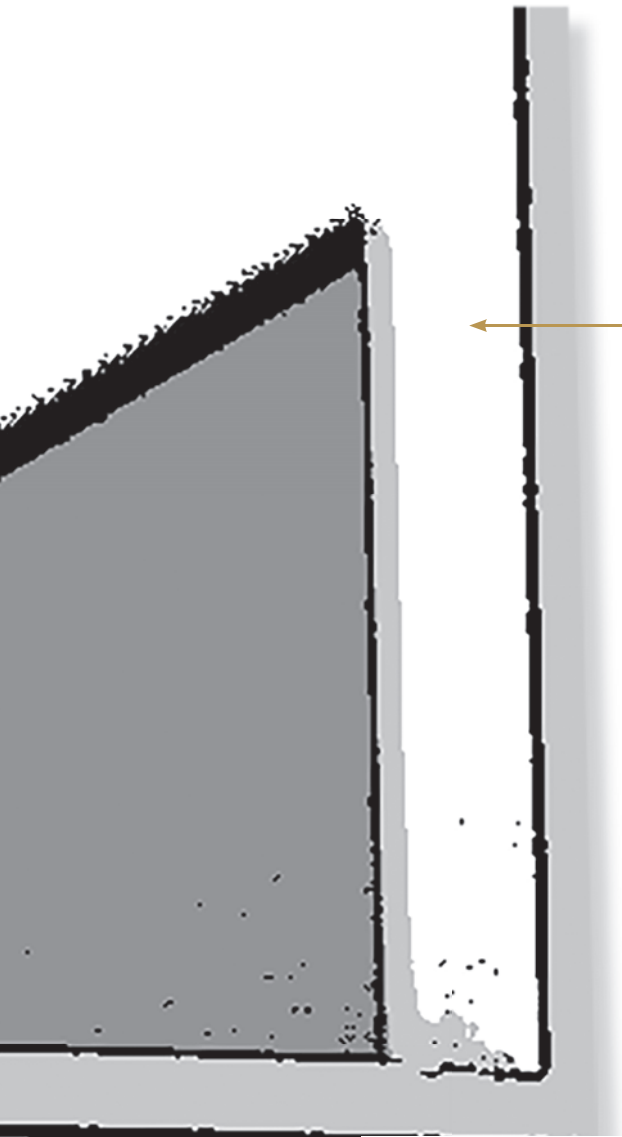

PROFIL U1925
PAGE 162

LES PRODUITS TECHNIQUES

PROFILS EN U



Nos profils en "U" sont livrés en longueur de 2 ml.

Possibilités de fabrications sur-mesure dans d'autres dimensions : délais de fabrication, nous consulter

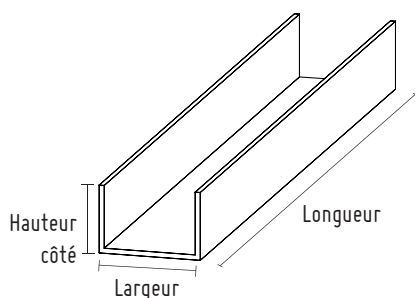

FINITION «PRÊT À PEINDRE» LISSE EXTÉRIEURE en 2 ml		
Réf.	Largeur	Hauteur
U1910	19 cm	10 cm
U1925	19 cm	25 cm
U2410	24 cm	10 cm
U2425	24 cm	25 cm
U3210	32 cm	10 cm
U3225	32 cm	25 cm

ÉQUERRES



Toutes nos équerres standardisées sont livrées en longueur de 2 ml.

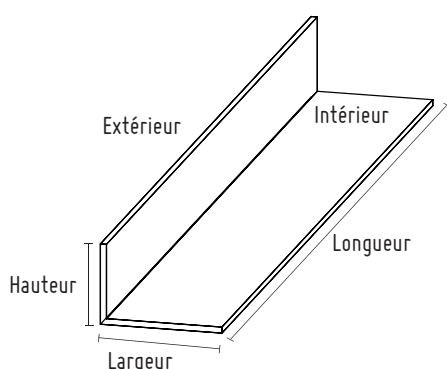

FINITION «PRÊT À PEINDRE» LISSE EXTÉRIEURE en 2 ml		
Réf.	Largeur	Hauteur
E0510E	5 cm	10 cm
E0520E	5 cm	20 cm
E0530E	5 cm	30 cm
E0535E	5 cm	35 cm
E1010E	10 cm	10 cm
E1020E	10 cm	20 cm
E1030E	10 cm	30 cm
E1040E	10 cm	40 cm
E1515E	15 cm	15 cm
E1520E	15 cm	20 cm
E2020E	20 cm	20 cm
E2030E	20 cm	30 cm

FINITION «PRÊT À PEINDRE» LISSE INTÉRIEURE en 2 ml		
Réf.	Largeur	Hauteur
E1020I	10 cm	20 cm
E1520I	15 cm	20 cm
E2020I	20 cm	20 cm
E2030I	20 cm	30 cm

FINITION «PRÊT À PEINDRE» ÉQUERRES BORD PROPRE en 2 ml		
Réf.	Largeur	Hauteur
EBP0530	30 cm	5 cm
EBP0830	30 cm	8 cm
EBP1030	30 cm	10 cm
EBP0525P	25 cm	5 cm

BANDEAUX BORDS PROPRES

BANDEAUX BORDS PROPRES DE 2ML		
Réf.	Largeur	Epaisseur
BP20	20 cm	1,8 cm
BP30	30 cm	1,8 cm

PLAQUES EN STAFF TRADITIONNELLES



Nous vous proposons la plaque de staff à l'unité ou sur palette de 30, 36 ou 50 unités, dans les dimensions et épaisseurs suivantes :



- PLAQ : 151 x 66 cm en épaisseur de 1,5 cm
- PLAQ2 : 120 x 80 cm en épaisseur de 1,5 cm
- PLAQ3 : 120 x 80 cm en épaisseur de 2 cm
- PLAQ5 ; 151 x 66 cm en épaisseur de 8 mm
- PLAQ6 : 120 x 80 cm en épaisseur de 8 mm

HABILLAGE DES NEZ DE CLOISONS

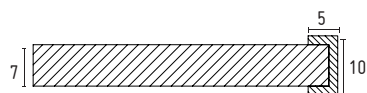

FINITION LISSE EXTÉRIEURE POUR NEZ DE CLOISON EN 2,50 ML		
Réf.	Largeur	Hauteur
UF1005	10 cm	5 cm

LE SYSTÈME DE CLOISONS & DE PLAFONDS



Accrochage mécanique sur ossature métallique. Finition des joints au plâtre pour le scellement.
Demandez à votre conseiller Staff Décor nos fiches techniques et conseils de pose !



Plaque de cloison



Plaque de plafond

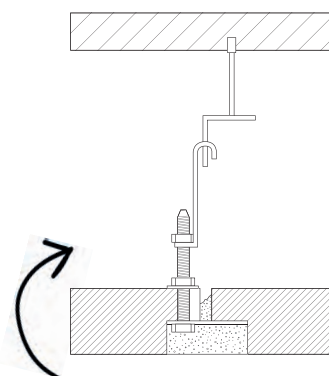

Vue en coupe du système de plafond (système breveté).

LES ENDUITS & MATÉRIEL DE POSE



La colle-enduit STAFF DÉCOR : Facile à travailler, elle reste blanche après séchage et peut être utilisée pour le collage, le rebouchage et la finition. Son utilisation est conseillée pour l'ensemble des produits de notre gamme.

- 0029 en sac de 5 Kg.
- 0010 en seau de 10 kg.
- 0028 en sac de 25 Kg.



Boîte à coupe adaptée à la dimension des corniches, que vous aurez réglée en fonction de leur encombrement sur le mur et le plafond (côtes de pose conseillées indiquées en face de chaque référence) :

- Boîte à coupe en 1 ml : 0005.
- Boîte à coupe en 2 ml : 0006.
- Boîte à coupe grand modèle en 2 ml : 0007.



Étais de pose télescopiques : 0018

Ces étais servent à soutenir l'élément collé pendant le temps de prise de l'enduit.

INDEX

Référence produit	Page	Référence produit	Page	Référence produit	Page
0005	163	1000	100-114	1130	40 - 106
0006	163	1001	114	1140C	102
0007	163	1002	114	1141C	103
0010	92 - 163	1003	100-114	1145C	103
0018	163	1004	114	1150	42 - 46
0028	163	1005	114 - 136	1150BH	46
0029	163	1025	114 - 137	1151	42 - 46
0034	104	1050	114 - 136	1151BH	46
0036	104	1055	114 - 136	1153	46
02	159	1101	41-40-47-145	1155	40
0710	129	1101BH	47	1156	40 - 105
0712	129	1101C	70 -103	1157	42
0714	128	1101D	47	1165	106
0724	128	1101F	47	1166	40
0726	128	1101G	47	1200	40 - 46
0732	129	1101H	47	1200BH	46
0734	128	1101P	47	1201	40
0742	129	1102	40 - 43 - 47	1202	40 - 47
0744	128	1102BH	47	1202B	47
0760	116	1103	40 - 46	1202BH	47
0761	116	1103BH	46	1202H	47
0762	116	1103C	103	1203	43 - 47
0765	116	1103D	44 -46	1204	12 - 42 - 47
0780	116	1103H	46	1204BH	47
0781	116	1104	42 - 46	1204H	13 - 45 - 47
0782	116	1104B	46	1205	42
0785	116	1104H	46	1206	40 - 46
0800	71 - 116	1105	42 - 46	1206R	46
0801	116	1105B	46	1206S	46
0802	116	1105H	46	1207	40 - 47
0803	116	1106	42	1207BH	47
0804	116	1107	40 - 47	1208	42 - 47
0805	116	1107BH	47	1208D	47
0806	116	1107P	47	1209	40
0900	117	1108	40 - 105 - 106	1210	40 - 46
0901	117	1109	42	1210BH	46
0902	117	1110	42	1250D	68
0903	117	1111	42	1250G	67 - 68
0904	117	1112	42	1251	68
0905	117	1113	42	1252	68
0950	115	1114D	42	1253	68
0951	115	1114G	42	1254	68
0952	115	1120	40 - 106	1271	68
0955	115	1121	40 - 106	1275	68
0999	114	1124	40 - 106	1301	38 - 42
100	159	1125	40 - 106 - 145	1302	38 - 42
				1303	13- 38 - 42
				1304	38 - 42
				1305	42
				1306	42
				1310	42
				1320	43
				1321	42

Référence produit	Page	Référence produit	Page	Référence produit	Page
1322	42	1420M	47	2624	142
1323	42	1420T	47	2630	142
1324	40	20.01	109	2718	142
1325	42	20.02	108 - 111	2724	142
1326	42	20.03	109	2730	142
1327	42	20.04	108	2800L	143
1328	42	20.05	108	2820L	143
1329	42	20.06	110 - 112	2824L	143
1330	42	20.06B	110 - 112	2830L	143
1331	42	20.06H	112	22104	140
1332	42	20.06S	110 - 112	22105	140
1333	42	20.08	110 - 112	22106	140
1334	43	20.51	109	22107	140
1335	43	20.52	108	22108	140
1340	42	20.53	109	22109	140
1341	43	20.54	108	22110	140
1342	43	20.55	108	22116	140
1343	40 - 136	20.56	110 - 112	22117	140
1344	40	20.56B	110 - 112	22118	140
1345	39-40-41-140	20.56H	112	22119	140
1346	43	20.56S	110 - 112	22120	140
1347	43	20.57	112	22121	140
1348	43	20.57BD	112	22122	140
1349	43	20.57BG	112	22130M	145
1364	40 - 106	20.57HD	112	22140	144
1365	40	20.57HG	112	22150	132
1366	40 - 106 - 136	20.57SD	112	22160.445	132
1367	40 - 106	20.57SG	112	22160.545	132
1371	43	20.58	110-112	22160.605	132
1372	43	20.59	112	22160.675	132
1373	43	201	68	30.02	110
1374	42 - 93	2000	100-113	30.03	110
1380	40	2001	113	30.04	110
1400	50	2004	100-113	30.05	110
1401	50	2005	113	30.06	110
1402	50	2019	140	30.07	110
1403	50	2020	113	30.08	110
1404	50	2024	70 - 140	30.09	110
1405	50	2030	115	30.10	110
1406	50	2030M	115	30.11	110
1407	50	2031	114 - 115	30.12	110
1408	50	2031C	115	30.52	110
1409	12 - 47	2031M	115	30.53	110
1410	47	2032	140	30.54	110
1411D	47	2039	140	30.55	110
1411G	47	2044	140	30.56	110
1412	50	2050	140	30.57	110
1413	50	2060	140	30.58	110
1414	50	2518	142	30.59	110
1415	50	2524	142	30.60	110
1416	50	2530	142	30.61	110
1420H	47	2618	142	30.62	110

Référence produit	Page	Référence produit	Page	Référence produit	Page
30.63	110	41.51	110	5032G	133
31.01	110	41.52	110	5033D	133
31.02	110	41.53	110	5033G	133
31.03	110	41.55	110	5034D	133
31.04	110	45.01	110	5034G	133
31.51	110	45.02	110	5041	134
31.52	110	45.03	110	5042	134
31.53	110	45.04	110	5043	134
31.54	110	45.05	110	5044	134
32.51	69	45.06	110	5051	134
3000	115	45.07	110	5052	134
3800	47	45.51	110	5053	134
3900	71 - 106	45.51C	69	5054	134
3901	107	45.52	110	5061D	134
3902	106	45.53	110	5061G	134
3903	107	45.54	110	5062D	134
3904	107	45.55	110	5062G	134
3905	106	45.56	110	5063D	134
3906	114	45.57	110	5063G	134
30051	134	4200	47	5071D	134
30052	134	4201	47	5071G	134
30053	134	50.050	65	5072D	134
30054	134	50.ATLA	65	5072G	134
30059	134	50.LET1	84	5073D	134
30061	133	50.LET2	84	5073G	134
30062	133	50.LET3	84	64	159
30063	133	50.NIAG	48 - 64 - 65	6200	129
30069	133	50.SIER	65	7001	117
40.01	108 - 109 - 111	50BC	159	7002	117
40.02	109	50BF	159	7003	117
40.03	108	52	159	7004	117
40.04	108 - 110	56	159	7005	117
40.05	109 - 110	57	159	7006	117
40.06	108 - 110	5001	133	7035	88
40.07	108	5002	133	7036	89
40.07A	108	5003	133	7036PLIN	89
40.08	108	5004	133	7036U	89
40.09	108	5011	133	7038	76
40.10	108 - 109	5012	133	7039A	90
40.20	109	5013	133	7039B	90
40.30	108	5014	133	7040	76
40.40	108 - 110	5021D	133	7041	76 - 77
40.50	109 - 110	5021G	133	7048	77
40.60	108 - 110	5022D	133	7049	77
40.61	69	5022G	133	7051	77
40.70	108	5023D	133	7053	77
40.70A	108	5023G	133	7060	76
40.80	108	5024D	133	7061	76
40.90	108	5024G	133	7062	91
41.01	110	5031D	133	7063	75 - 91
41.02	110	5031G	133		
41.03	110	5032D	133		

Référence produit	Page	Référence produit	Page	Référence produit	Page
7063-1	91	942.73	105	9411	101
7063-2	91	942.83	105	9412	101
7063-3	91	943.63	105	9413	101
7063-4	91	943.73	105	9450	100
7070	82	943.83	105	9451	100
7071	82	950.63	105	9460	100
7072	82 - 83 - 119	950.73	105	9461	100
7073	78 - 82	950.83	105	97300	153
7074	82	952.63	105	98000	152
7075	82	952.73	105	98006	152
7078	84	952.83	105	98500	152
80	159	960.00	104	98506	151 - 152
901.63	105	9001	103	98510	152
901.73	105	9002	103	98520	153
901.83	105	9003	103	98530	153
902.63	105	9011	103	98540	153
902.73	105	9012	103	A.0T20/24	131
902.83	105	9013	103	AA-R1707	131
903.63	105	9020	102	APPLIQUES série 110	6
903.73	105	9021	102	B700	66 - 69
903.83	105	9025	102	B701	69
911.63	105	9031	103	B702	69
911.73	105	9032	103	B703	69
911.83	105	9033	103	BL120	26 - 27
912.63	105	9201	99	BL130	28
912.73	105	9202	99	BL131	28
912.83	105	9203	99	BL132	28
913.63	105	9204	99	BL140	28
913.73	105	9205	99	BL160	28
913.83	105	9206	99	BL170	29
921.63	105	9211	99 - 102	BL170R25E	29
921.73	105	9212	99	BL170R25I	29
921.83	105	9213	99	BL170R50E	29
922.63	105	9214	99	BL170R50I	29
922.73	105	9215	99	BL180	9
922.83	105	9216	99	BP20	162
930.63	105	9221	99	BP30	162
930.73	105	9222	99	CHEVET1	131
930.83	105	9223	99	CHEVET2D	131
9315.23	101	9224	99	CHEVET2G	131
9315.30	101	9225	99	CIEL DE LIT	7
9315C	98 - 102	9226	99	CL10	92 - 143
932.63	105	9280	101	CL11	92
932.73	105	9301	98	CL12	94 - 95
932.83	105	9302	98	CL1374	93 - 95
933.63	105	9303	98	CL31	74
933.73	105	9310	98	CL31A	86
933.83	105	9311	98	CL31B	86
940.63	105	9312	98	CL32	78 - 79 - 87
940.73	105	9401	101	CL33	87
940.83	105	9402	101	CL34	88
942.63	105	9403	101	CL35	88

Réf. produit	Page	Réf. produit	Page	Réf. produit	Page	Réf. produit	Page
CL36	8-88	D604	31	D801	30 - 33	E2030E	162
CL37	8	D605	31	D802	30	E2030I	162
C080	37	D606	32	D810	34	EBL0430	27
C090	37	D607	32	D812	35	EBP0525P	162
C0100	37	D608	31	D813	35	EBP0530	162
C0105	37	D609	31	D814	34	EBP0830	162
C0110	37	D610	31	D815	34	EBP1030	162
C0120	37	D611	31	D818	36	EMB95	27
D101	25	D612	31	D820	33	ENC31	10
D102	25	D614	31	D830	31	ENC32	10
D103	25	D615	36	D835	36	ENC35	10
D104	25	D616	32	D840	34	ENC41	11
D105A	25	D617	34	D843	35	JC22.10	23
D105B	25	D620	19	D844	35 - 37	JC22.20	23
D106	26	D621	19	D845	35	JC22.30	23
D107	26	D622	32	D846	36	JC22.40	23
D108	26	D623	32	D880	32	JC55.10	23
D110	26	D624	32	D880A	32	JC55.20	23
D118	9	D625	31	D880B	6	M038	50
D121	9	D626	31	D884	35	M039	59
D505	35 - 37	D627	36	D885	35	M040	51
D510	35 - 37	D628	34	D886	33	M041	51
D513	36	D629	34	D888	33	M042	51
D515	34	D630	31	D889	34	M043	51
D520	31	D631	19	D890	36	M044	51
D525	36	D650	32 - 33	D890A	36	M045	53
D530	36 - 137	D651	32	D891	18	M046	53
D531	34	D652	32	D892	30	M047	51
D535	36	D653	33	D893	35	M048	59
D540	36	D654	32	D894	35	M049	50
D545	31	D655	36	D895	35	M050	50
D550	36	D656	33	D896	33	M051	52
D555	19	D657	33	D897	35	M052	55
D560	30	D702	32	D898	16 - 34	M053	53
D561	19	D703	31	D899	34	M054	62
D562	19	D704	31	D900	30	M055	53
D563	19	D705	19	D901	19	M056	52
D564	18	D706	19	D902	34	M057	52
D565	18 - 19	D707	31	E0510E	162	M058	51
D566	35	D708	24	E0520E	162	M059	52
D567	18	D709	24	E0530E	162	M060	63
D568	18	D710	24	E0535E	162	M061	52
D569	34	D711	36	E1010E	162	M066	62
D570	35	D712	36	E1020E	162	M067	60
D574	31	D713	33	E1020I	162	M068	59
D575	17 - 19 - 119	D715	34	E1030E	162	M069	59
D576	19	D716	36	E1040E	162	M070	55
D577	18 - 20	D717	33	E1515E	162	M071	13 - 59
D578	19	D718	19	E1520E	162	M072	52
D579	18	D720	19	E1520I	162	M073	52
D580	19	D748	24	E2020E	162	M100	51
D601	30 - 37	D749	24	E2020I	162	M101	51

Référence produit	Page	Référence produit	Page	Référence produit	Page
M102	51	MOA24	125	S606	32
M201	53	MOAC	125	S611	32
M202	52	MOAPLIN10	125	S616	32
M203	59	MOAPLIN10M	125	S702	32
M204	52	MOAPLINT	125	S707	32
M205	52	MOAS	125	S908	22
M206	53	MOD05	124 - 127	S908A	22
M207	53	MOD06	124	SD7042	76
M208	59	MOD23	122 - 124	SD7043	80
M209	59	MOD24	124 -125 -126	SD7044	80
M210	59	MOD25	124	SD7045	84
M211	51	MODC	124	SD7046	85
M212	62	MODS	124	SD7047	76
M213	53	MOE45	124	SD7052	80
M250	63	MOE60	124	SD7054	76
M251	63	MOE90	124	SD7055	79 - 84
M252	63	MOE120	124	SD7056	76
M253	63	OPT140	144	SD7057	80
M254	54	OPT141	144	SD7500	79 - 81
M255	61	PL222	157	SD7501	81
M296	61	PL223	157	SD7502	81
M297	54	PL304	156	SD7503	81
M298	62	PL314	156	SD7504	81
M299	54	PL324F.BF	155 - 156	SDC1	103
M300	54	PL621	158	SDC2	103
M301	49 - 54	PL621E.BF	158	SPOT	144
M302	55	PLAQ	162	SV577	21
M303	55	PLAQ2	162	SV748	21
M304	55	PLAQ3	162	T.CAPITON165	130
M306	62	PLAQ5	162	T.CAPITON180	130
M390	60	PLAQ6	162	T.OCEAN160	130
M400	61	PLIN08	103	T.OCEAN180	130
M401	56	PLIN08M	103	T.SAHARA140	131
M402	56	PLIN10	103	T.SAHARA160	131
M403	56	PLIN10A	103	T.SAHARA180	131
M404	60	PLIN10M	103	TAL12	106
M405	57	PLIN12	103	TAL14	106
M406	61	PLIN12A	103	TAL17	106
M407	58	PLIN15	103	TALGM	106
M420	69	PLIN15A	103	TALP	77
M421	69	PLIN20	103	TALSP	106
M422	69	PLINT	103	U1910	162
M501	63	PLINTA	103	U1925	161 - 162
M502	62	R561	37	U2410	162
M05-242	127	R601	32	U2425	162
M05-245	127	R606	32	U3210	162
M05-545	127	R611	32	U3225	144 - 162
M05-B115	127	R616	32	UF1005	163
M05-ET398	127	R702	32	US0740	23
M05-F0398	127	R707	32	US1040	23
M05-H115	127	S562	37	VER56	144
MOA23	125	S601	32	VER90	144

10 showrooms en France pour répondre à vos besoins !

CAEN
Z.I. EST - Rue de Bellevue
14650 CARPIQUET
Tél. 02 31 26 27 60
Fax. 02 31 26 27 66
email : ag14@staffdecor.fr

MANUFACTURE ET SIÈGE SOCIAL
Z.A. de l'Hermitière, Route de Nantes
35230 Orgères (Sud de Rennes)
Tél. 02 99 42 30 30 - Fax (33) 02 99 42 36 36
email : info@staffdecor.fr

STRASBOURG
Z.I. - 22, rue des Tuileries
67460 SOUFFELWEYERSHEIM
Tél. 03 90 20 37 73
Fax. 03 90 20 39 11
email : ag67@staffdecor.fr

VANNES
Z.I. du Prat - 23, rue du Général Baron Fabre
56000 VANNES
Tél. 02 97 54 25 55
Fax. 02 97 54 00 11
email : ag56@staffdecor.fr

PARIS
ZAC du Plateau - 18, rue des Marronniers
94240 L'HAY-LES-ROSES
Tél. 01 48 52 73 23 - Fax. 01 48 52 52 46
email : ag94@staffdecor.fr

TOURS
Z.I. N°2 - 18, rue Etienne Cosson
37170 CHAMBRAY LES TOURS
Tél. 02 47 28 59 66
Fax. 02 47 27 99 84
email : ag37@staffdecor.fr

BORDEAUX
170, cours Médoc - Galerie Tatry
33000 BORDEAUX
Tél. 05 56 29 09 65
Fax. 05 56 29 09 67
email : ag33@staffdecor.fr

LYON
9, boulevard Lucien Sampaix
69190 SAINT-FONS
Tél. 04 78 67 17 17
Fax. 04 78 67 18 18
email : ag69@staffdecor.fr

MARSEILLE
240, av. de Coullins - P. d'activité
13420 GEMENOS
Tél. 04 42 32 22 11
Fax. 04 42 32 22 44
email : ag13@staffdecor.fr

NICE
27, boulevard de Riquier
06300 NICE
Tél. 04 93 89 77 82
Fax. 04 93 89 77 94
email : ag06@staffdecor.fr



FABRICANT

Nos catalogues de collections téléchargeables sur :



www.staffdecor.fr